



Sunny Boy 6000U



Installation Guide

Copyright © 2003 SMA America, Inc. All rights reserved.

No part of this document may be reproduced, stored in a retrieval system, or transmitted, in any form or by any means, electronic, mechanical, photographic, magnetic or otherwise, without the prior written permission of SMA America, Inc.

SMA America makes no representations, express or implied, with respect to this documentation or any of the equipment and/or software it may describe, including (with no limitation) any implied warranties of utility, merchantability, or fitness for any particular purpose. All such warranties are expressly disclaimed. Neither SMA America nor its distributors or dealers shall be liable for any indirect, incidental, or consequential damages under any circumstances.

(The exclusion of implied warranties may not apply in all cases under some statutes, and thus the above exclusion may not apply.)

Specifications are subject to change without notice. Every attempt has been made to make this document complete, accurate and up-to-date. Readers are cautioned, however, that SMA America reserves the right to make changes without notice and shall not be responsible for any damages, including indirect, incidental or consequential damages, caused by reliance on the material presented, including, but not limited to, omissions, typographical errors, arithmetical errors or listing errors in the content material.

Revision History

Rev. No.	Date	By	Version
1.0	April 21, 2004	YS	First ROW
2.0	August 9, 2004	JP	First US
2.1	October 14, 2004	JP	US 2.1
2.2	December 3, 2004	JP	Updated
2.3	March 21, 2005	JP	Pins, graphs, fusing, illustrations, language
3.0	April 29, 2005	JP	Jumpers, label, re-org, doc number
3.1	July 21, 2005	JP	Additional ratings added
3.2	June 2006	JP	Positive ground information added

SMA America, Incorporated
12438 Loma Rica Drive
Grass Valley, California 95945

Tel 530.273.4895
Fax 530.274.7271
www.sma-america.com

IMPORTANT SAFETY INSTRUCTIONS

SAVE THESE INSTRUCTIONS

This manual contains important instructions for the Sunny Boy 6000U that must be followed during installation and maintenance of the inverter.

The Sunny Boy is designed and tested according to international safety requirements, but as with all electrical and electronic equipment, certain precautions must be observed when installing and/or operating the Sunny Boy. To reduce the risk of personal injury and to ensure the safe installation and operation of the Sunny Boy, you must carefully read and follow all instructions, cautions and warnings in this *Installation Guide*.

Safety and Hazard Symbols



This symbol is used to call attention to important information that you must have when installing and/or operating the Sunny Boy. Failure to read and follow instructions marked with this symbol could result in injury or death and/or damage to the equipment.



This symbol appears beside instructions and warnings that deal with dangerous voltages that can injure or kill people who come in contact with them.



This symbol appears beside terminations that are connected to earth-ground.

Warnings



WARNING: A Warning describes a hazard to equipment or personnel. It calls attention to a procedure or practice, which, if not correctly performed or adhered to, could result in damage to or destruction of part or all of the SMA equipment and/or other equipment connected to the SMA equipment or personal injury.

Warnings and Cautions may also be accompanied by one or more of the safety and hazard symbols described above to indicate the type of hazard described therein.

Other Symbols

In addition to the safety and hazard symbols described on the previous pages, the following symbol is also used in this *Installation Guide*:



This symbol accompanies notes that call attention to supplementary information that you should know and use to ensure optimal operation of the system.

General Warnings



All electrical installations must be done in accordance with the local and National Electrical Code ANSI/NFPA 70.



The Sunny Boy contains no user-serviceable parts except for the fans on the bottom of the enclosure and the filters behind the fans as well as the exhaust fins on the sides of the unit. For all other repair and maintenance always return the unit to an authorized SMA Service Center.



Before installing or using the Sunny Boy, read all of the instructions, cautions, and warnings on the Sunny Boy, the PV array, and in this Installation Guide.



Before connecting the Sunny Boy 6000U to the electrical utility grid, contact the local utility company. This connection must be made only by qualified personnel.



PV arrays produce electrical energy when exposed to light and thus can create an electrical shock hazard. Wiring of the PV-arrays should only be performed by qualified personnel.

Warranty

All Sunny Boy inverters sold in the USA have a five-year warranty, as indicated on the warranty card included in the Sunny Boy shipping container. For warranty coverage, or if you have questions about the Sunny Boy warranty, contact SMA America at the address, telephone number or Web site listed on page i (to send E-mail, see the Contact section of the SMA America Web site).

Contents

Revision History	i
Safety and Hazard Symbols	iii
Warnings.	iv
Other Symbols	iv
General Warnings.	1-v
Warranty.	v
1 Introduction	
Product Overview	1-1
Safety	1-2
Installation Overview.	1-4
2 Unpacking and Inspection	
3 Mounting	
Choosing a Mounting Location	3-1
Dimensions and Recommended Clearances	3-3
Mounting Procedure	3-5
4 Input Voltage Configuration	
Opening the Sunny Boy 6000U	4-1
Locating Internal Components	4-1
Configuring the Input Voltage	4-3
5 Wiring the SB6000U	
Wiring the AC Output.	5-3
AC Connection Requirements	5-3
Connecting the AC Wires.	5-6
Wiring the DC Input	5-8
DC Connection Requirements	5-8
DC Input Grounding	5-9
Connecting the DC Wires	5-12
Communication Wiring	5-14
RS-232 Communication	5-14
RS-485 Communication	5-17
Replacing the Cover.	5-19
6 Commissioning	

7	Displays and Messages	
	LED Fault Indicators	7-6
	Status Messages on the LCD Display	7-11
	Communication Options	7-14
8	Troubleshooting	
	General	8-1
	Error Messages	8-3
9	Maintenance	
	Cleaning the Fans	9-1
	Testing the Fans	9-2
	Cleaning the Exhaust Fins	9-3
10	Technical Specifications	
	FCC Compliance Information	10-1
	Sunny Boy SB6000U Wiring Diagrams	10-2
	Specifications	10-3

Section 1: Introduction

This installation guide provides all the information needed to install, commission and operate a Sunny Boy 6000U (SB6000U) grid-tied photovoltaic (PV) inverter.



Note: To help avoid problems during the installation, familiarize yourself with the installation process by reading the entire *Installation Guide* before starting the installation.



WARNING: Lethal voltages are present at various points in a PV system. For safety reasons, it is recommended that only qualified personnel install and operate this equipment.

Product Overview

The SB6000U is a DC to AC grid-tied utility interactive inverter for use with photovoltaic (PV), fuel cell, wind turbine and other sources of DC power.

In general, the SB6000U takes power from a DC source (PV modules) and converts it to AC power for the utility grid. This power is delivered first to local loads (household appliances, lights, motor loads, etc.), with any excess power fed to the utility. The power consumed by the local loads reduces the power needed from the utility. Excess power may actually “spin the utility meter backwards” depending on the type of meter in your system. This power may also be recorded as power credits by the utility company depending on the interconnection agreement. An example of basic system components is shown in Figure 1-1.

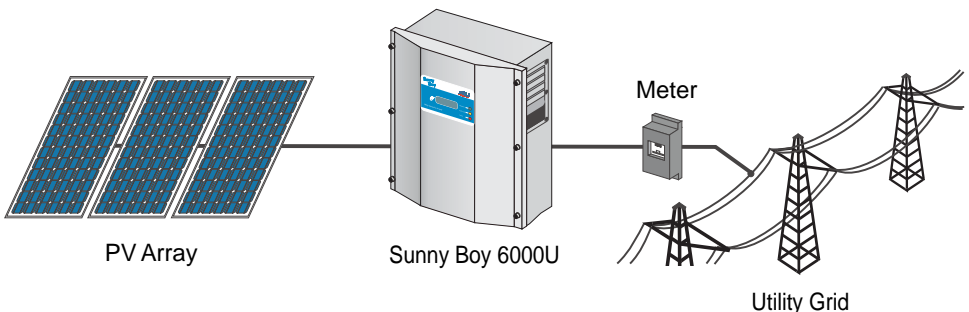

Figure 1-1 Sunny Boy 6000U Installed in a Utility Interactive PV System



Note: Policies vary from one utility company to another. Consult with a representative of the local utility company before designing and installing a PV system.

Safety

Anti-Islanding Protection

Islanding is a condition that can occur if the utility grid is disconnected while the SB6000U is operating and the remaining load is resonant at 60 Hz and matches the output of the SB6000U perfectly. This condition is highly unlikely and had never been witnessed outside of a controlled laboratory. Nevertheless, the SB6000U incorporates an advanced active islanding protection algorithm to insure that the system will not export power into a balanced 60 Hz resonant load while the utility is disconnected. The SB6000U periodically injects both leading and lagging reactive current into the utility grid. This method has been proven by Underwriters Laboratories to effectively destabilize and disconnect from a balanced island condition.

PV Ground Fault Detection and Interruption

The SB6000U is equipped with a ground fault detection device. If a ground fault current greater than 1 Amp is detected, the SB6000U will shut down and display the fault condition on the user interface display. Once the ground fault is located and corrected, the ground fault error will need to be manually cleared and the inverter will then resume normal operation.

PV Series Fusing

Series fusing may be required depending on the type of PV module used in the system. See NEC 690.9

Interconnection Code Compliance

The Sunny Boy SB6000U has been tested and listed by Underwriters Laboratories to meet the requirements of **UL1741 Static Inverters and Charge Controllers for use in Photovoltaic Power Systems** and **UL1998 Software in Programmable Components**, as well as **IEEE-929-2000 Recommended Practice for Utility Interface of Photovoltaic Systems** and **IEEE 519 Standard Practices and Requirements for Harmonic Control in Electrical Power Systems**. The SB6000U is also listed under UL1741 for Canadian UL.



UL1741 is the standard applied by Underwriters Laboratories to the SB6000U to certify that it meets the requirements of the NEC and IEEE-929-2000. IEEE 929-2000 provides recommendations regarding the proper equipment and functionality necessary to ensure compatible operation when power generation is connected to the utility grid.



Note: Contact the local utility and/or the authority having jurisdiction prior to connecting the Sunny Boy 6000U to the utility grid.

FCC Compliance

The SB6000U has been tested and shown to conform with all FCC Part 15 B EMI/EMC emissions regulations.

Feature Overview

Over twenty years of inverter manufacturing experience has gone into the design of the SB6000U. As a result, the SB6000U represents state-of-the-art technology, high reliability and over all ease of use - all the qualities you've come to expect from the industry leader in inverter manufacturing. Some of the features included are:

- LCD Display
- Temperature regulated fan cooling - simple replacement
- Auto line voltage detection and configuration
- Advanced communication options available
- Compatible with all Sunny Boy and Sunny Boy Control products
- High efficiency
- Quiet operation
- Simple installation
- Stainless steel enclosure

Operating Temperature

The SB6000U has been designed to maintain full power output at ambient temperatures as high as 45°C. Fan cooling allows this level of output power to be achieved even in enclosed spaces. The SB6000U will continue to operate well beyond 45°C and de-rates as needed to maintain a safe internal component temperature.

Installation Overview

This section provides a high-level overview of the installation process so you have an idea what to expect as you proceed through the rest of the *Installation Guide*.

The installation process is broken down into the following tasks:

Section 2: Unpacking and Inspection

This section provides instructions and information for unpacking the SB6000U and inspecting it for shipping damage.

Section 3: Mounting

This section includes guidelines to help you select the best mounting location, suggestions to insure optimum performance, cautions and warnings that you should follow to avoid injury and/or equipment damage and step-by-step instructions for mounting the SB6000U inverter.

Section 4: Input Voltage Configuration

This section includes information on removing the cover, locating primary components within the inverter and selecting the appropriate voltage configuration for the installation.

Section 5: Wiring the SB6000U

This section includes guidelines for selecting the correct wire sizes, cautions and warnings that you should follow to avoid injury and/or equipment damage and step-by-step instructions for wiring the SB6000U to a PV array, household electrical circuits and the utility grid. Procedures are also included for connecting optional data-communication cables.

Section 6: Commissioning

Commissioning involves applying DC input power to the SB6000U, observing the LED and LCD indicators on the front cover, and resolving any problems that occur.

Section 7: Displays and Messages

This section provides troubleshooting tips and procedures for resolving problems that may occur during installation and operation.

Section 2:

Unpacking and Inspection

All Sunny Boy inverters are thoroughly tested and inspected before they are packed and shipped. Although they are shipped in sturdy, recyclable packaging; damage can still occur during shipping. It is important to carefully inspect the shipping container prior to beginning the installation. If any external damage to the packaging makes you suspect the inverter itself could be damaged, or if you find that the inverter is damaged after unpacking it, report the damage immediately to your SMA dealer and to the shipping company that delivered the Sunny Boy. If it becomes necessary to return the Sunny Boy, use the original packaging in which it was delivered.



WARNING: The Sunny Boy 6000U weighs 141 lb. (63 kg). To avoid injury, be sure to use proper lifting techniques and secure the help of someone to assist in the unpacking and installation of the inverter.

If you need assistance with a damaged Sunny Boy, contact your SMA dealer or SMA America. Contact information for SMA America is provided below.

SMA America, Incorporated
12438 Loma Rica Drive
Grass Valley, California 95945
Tel 530.273.4895
Fax 530.274.7271
www.sma-america.com

Section 3:

Mounting

This section provides guidelines to help you select the best mounting location, suggestions to insure optimum performance, cautions and warnings that you should follow to avoid injury and/or equipment damage, and step-by-step instructions for mounting a Sunny Boy 6000U inverter.



WARNING: The Sunny Boy 6000U weighs 141 lb. (63 kg). To avoid injury, be sure to use proper lifting techniques and secure the help of someone to assist in the unpacking and installation of the inverter.



Note: Occasionally, the rating label on the SB6000U will need to be referred to. For this reason, it is required that the inverter be mounted so that the rating label on the side of the inverter is visible.

Choosing a Mounting Location

Consider the following guidelines, cautions, and warnings when choosing a mounting location for the SB6000U:

- **Do not install the SB6000U in direct sunlight.** External heating from exposure to the sun may cause excessive internal heating. This can result in derated output power to protect the internal components from damage.
- Install the SB6000U in a location that maintains an ambient air temperature that is less than 45°C. To maintain a safe internal component temperature, the SB6000U may power derate if the ambient air temperature exceeds 45°C. (The cooler the air temperature, the longer the life expectancy of any power electronics device.)
- The SB6000U is constructed in a rugged stainless steel enclosure designed for outdoor installations. However, care should always be taken to minimize exposure to the elements. It is best to minimize exposure to rain, snow and ice, etc. Do not install the SB6000U in a location exposed to sources of direct water spray such as sprinklers or downspouts.
- The inverter should be installed in a location that is inaccessible to children.
- The SB6000U emits a slight vibrating noise when operating. This vibration is normal and has no effect on performance, but it can be objectionable if the inverter is mounted on a wall in a living area, on the outside of a wall that is near a living area, or on certain types of materials, such as thin wood panelling or sheet metal.

- If the inverter is installed outside, it should be mounted vertically (see Figure 3-1).

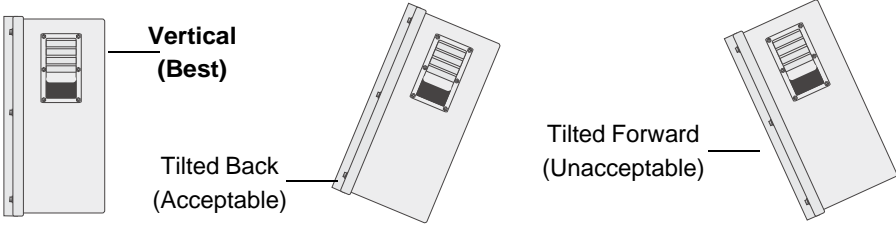

Figure 3-1 Sunny Boy Mounting Positions



CAUTION: The Sunny Boy 6000U weighs 141 lb. (63 kg.). Ensure that the mounting surface is strong enough to hold the weight of the SB6000U. Do not mount the Sunny Boy on plasterboard (sheet-rock) or thin wood panelling.



CAUTION: Rain-tight or wet location hubs that comply with the requirements in the Standard for Fittings for Cable and Conduit, UL 514B, are to be used.



CAUTION: Do not install the SB6000U during periods of precipitation or high humidity (>95%). Moisture trapped within the enclosure may cause corrosion and damage to the electronic components.



CAUTION: If you are installing the Sunny Boy in a cabinet, closet, or other relatively small enclosed area, you must provide sufficient air circulation to dissipate the heat generated by the inverter.



WARNING: To prevent electrical shock or other injury, check for existing electrical or plumbing installations in the walls before drilling mounting holes for the Sunny Boy.

Dimensions and Recommended Clearances

The outer dimensions of the Sunny Boy 6000U are shown in Figure 3-2. The Sunny Boy must be mounted so that there is at least eight inches of clearance around the Sunny Boy 6000U.

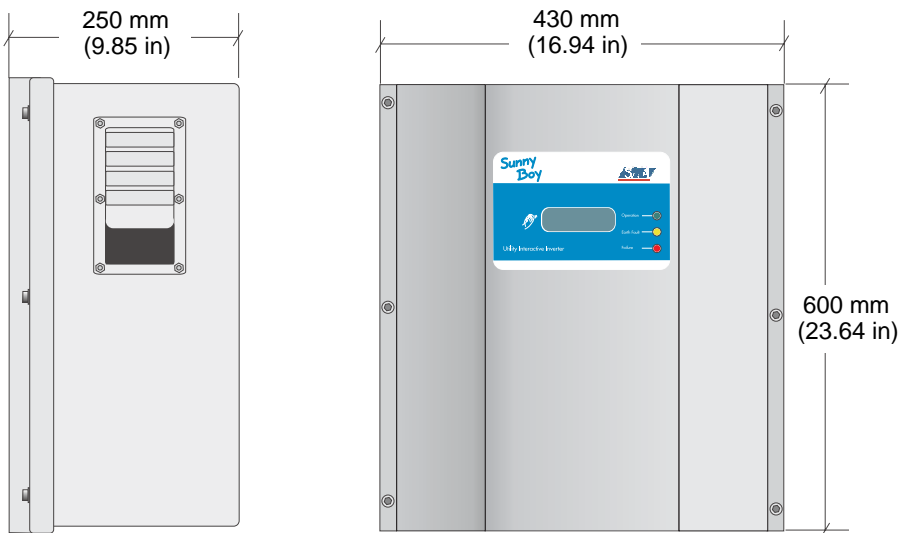

Figure 3-2 Outer Dimensions of the Sunny Boy 6000U



CAUTION: You **must** ensure that there is sufficient clearance for the flow of the air around the Sunny Boy! In a normal operating environment with good ventilation, eight inches of clearance is adequate.



Note: The National Electrical Code may require significantly larger working clearances (see NEC Section 110.26).

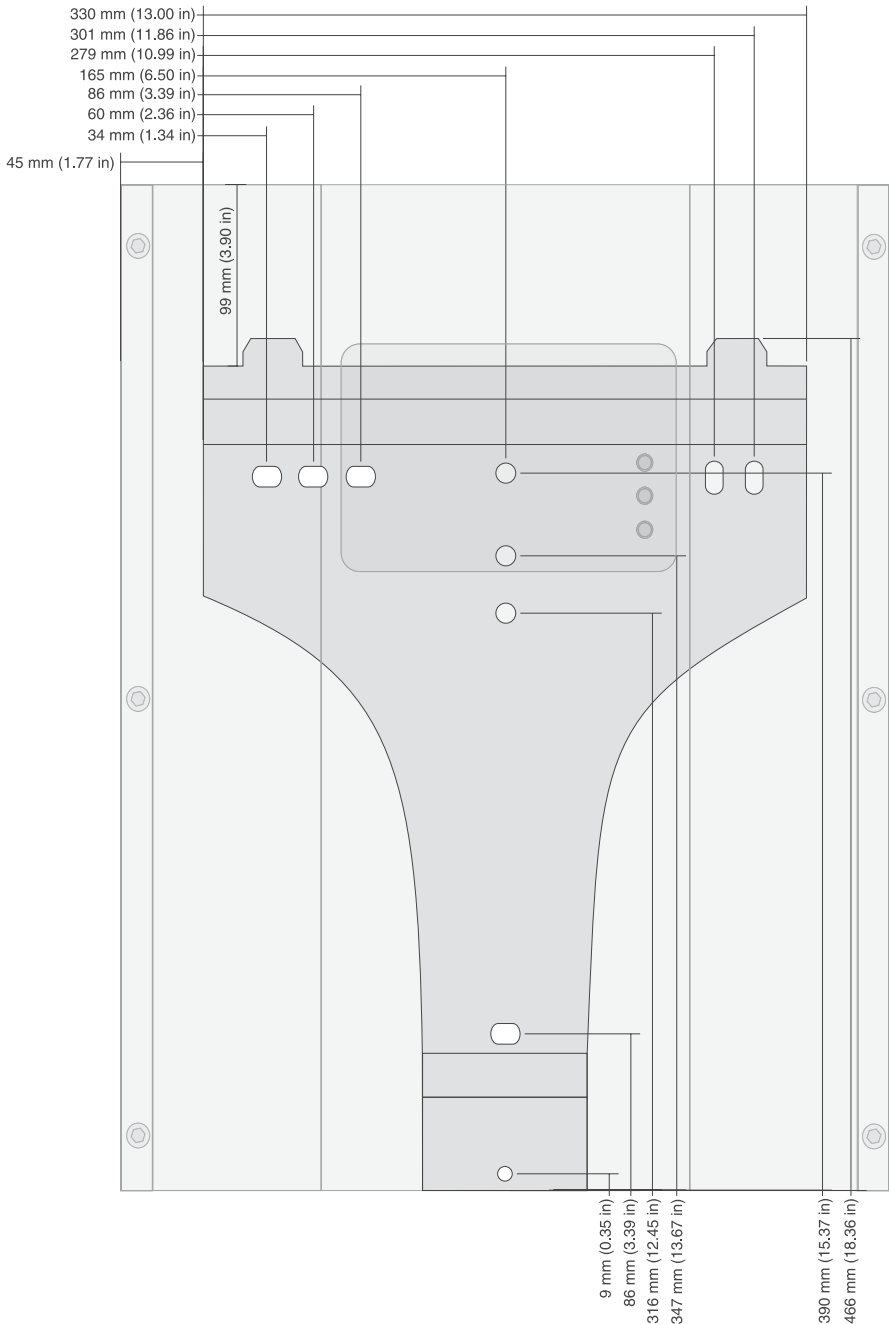

Figure 3-3 Dimensions of the Wall Mounting Bracket

Mounting Procedure

The Sunny Boy 6000U is shipped with a T-shaped wall-mounting bracket that is suitable for use with most walls (see Figure 3-4). The horizontal part of the bracket has five holes spaced on 16-inch centers for mounting on wooden stud walls. Make sure that the wall you choose to mount the Sunny Boy on is sturdy enough to support its weight (63 kg/ 141 lb.) over a long period of time and that the wall is plumb. The bracket may also be mounted on stone, brick or solid walls. Be sure to use the appropriate type of mounting hardware for the wall material and ensure that the hardware is no smaller than 1/4".

Stone wall mounting

Wood wall mounting

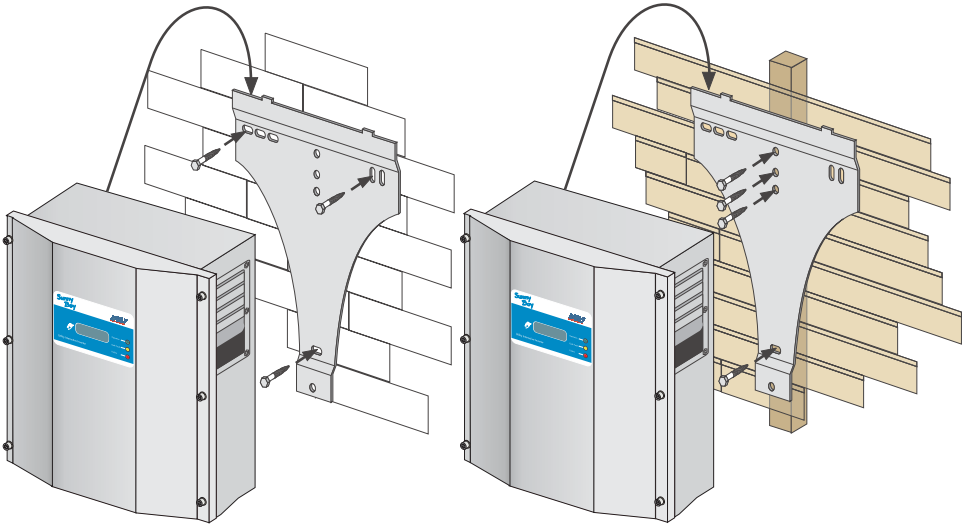

Figure 3-4 Sunny Boy 6000U with Mounting Bracket

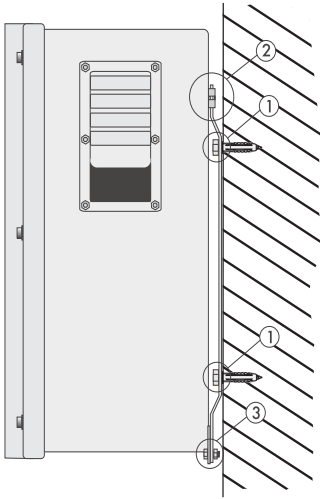

Figure 3-5 Mounting the Sunny Boy 6000U

Use the following procedure to mount the SB6000U:

1. Locate the T-shaped wall-mounting bracket included in the shipping container with the SB6000U. Remove the hex screw at the bottom of the bracket and set it aside.
2. Position the wall-mounting bracket against the wall where you intend to mount the SB6000U. (Try to mount the SB6000U so that the display is approximately at eye-level.) Place a level on the top edge of the bracket, and adjust the position of the bracket until it is level. The bottom of the bracket will be the approximate location of the bottom of the inverter.
3. Using the wall-mounting bracket as a template, mark the wall through three holes in the horizontal portion of the bracket.



CAUTION: Ensure that there are studs in the wall at the places where you intend to drill the mounting-holes. **DO NOT** use molly or toggle bolts to mount the SB6000U to sheet rock or panelling.

4. Set the bracket aside temporarily, and drill holes at the marks you made on the wall.



Note: The diameter of the holes you drill must match the hardware you are using to mount the SB6000U. For example, if you are mounting the SB6000U to a concrete wall, the hole diameter should be approximately the same as the outside diameter of the concrete anchors you intend to use. If you are mounting the SB6000U on a wall that has wooden studs inside it, the hole diameter should be the correct size for the lag screws you intend to use to mount the bracket. If you are installing the SB6000U outside, it is recommended that the lag screws be made of stainless steel, and the diameter of the screws closely match the diameter of the holes in the wall-mounting bracket. Make sure that the screws are long enough to penetrate the wall to a depth of 1 and 1/2".

5. Insert the screws through the holes in the wall-mounting bracket and into the holes you drilled in the wall. Tighten the screws until the bracket is held firmly against the wall (see Figure 3-4). Do not overtighten the screws.
6. Carefully lift the SB6000U onto the mounting bracket. There are a pair of metal channels welded to the back of the SB6000U. These brackets sit on the pair of tabs on the top edge of the mounting bracket. Mount the SB6000U so that it hangs on these tabs. (see Figure 3-4).



WARNING: The Sunny Boy 6000U weighs 141 lb. (63 kg). To avoid injury, be sure to use proper lifting techniques and secure the help of someone to assist in the unpacking and installation of the inverter.

7. Inspect the SB6000U from both sides to ensure that the channels on the back of the SB6000U sit completely on the tabs on the top edge of the mounting bracket and that the SB6000U is centered on the bracket.
8. Replace the hex screw through the hole in the mounting strap and into the threaded hole in the bottom end of the wall-mounting bracket (see Figure 3-4).
9. Tighten the screw. (Do not overtighten)
10. Carefully verify that the Sunny Boy 6000U is firmly mounted in place.

Section 4:

Input Voltage Configuration

Opening the Sunny Boy 6000U

Remove the six screws and lock washers that attach the cover of the SB6000U. Place the cover, screws, and lock washers aside where they will be out of your way while you are connecting wires and cables to the Sunny Boy.



CAUTION: *Be careful not to misplace the screws or the lock washers, as all six screws and lock washers are required to ensure that the cover is grounded properly and is fully sealed to the case. Handle the cover carefully, as even minor damage to the cover could result in an inadequate seal between the cover and the case, thus allowing moisture to enter the case and damage the sensitive electronic components.*



CAUTION: Do not install the SB6000U during periods of precipitation or high humidity (>95%). Moisture trapped within the enclosure may cause corrosion and damage to the electronic components.

Locating Internal Components

Figure 4-1 illustrates the locations of the major internal components of the SB6000U. Refer to this illustration as needed to locate particular components.

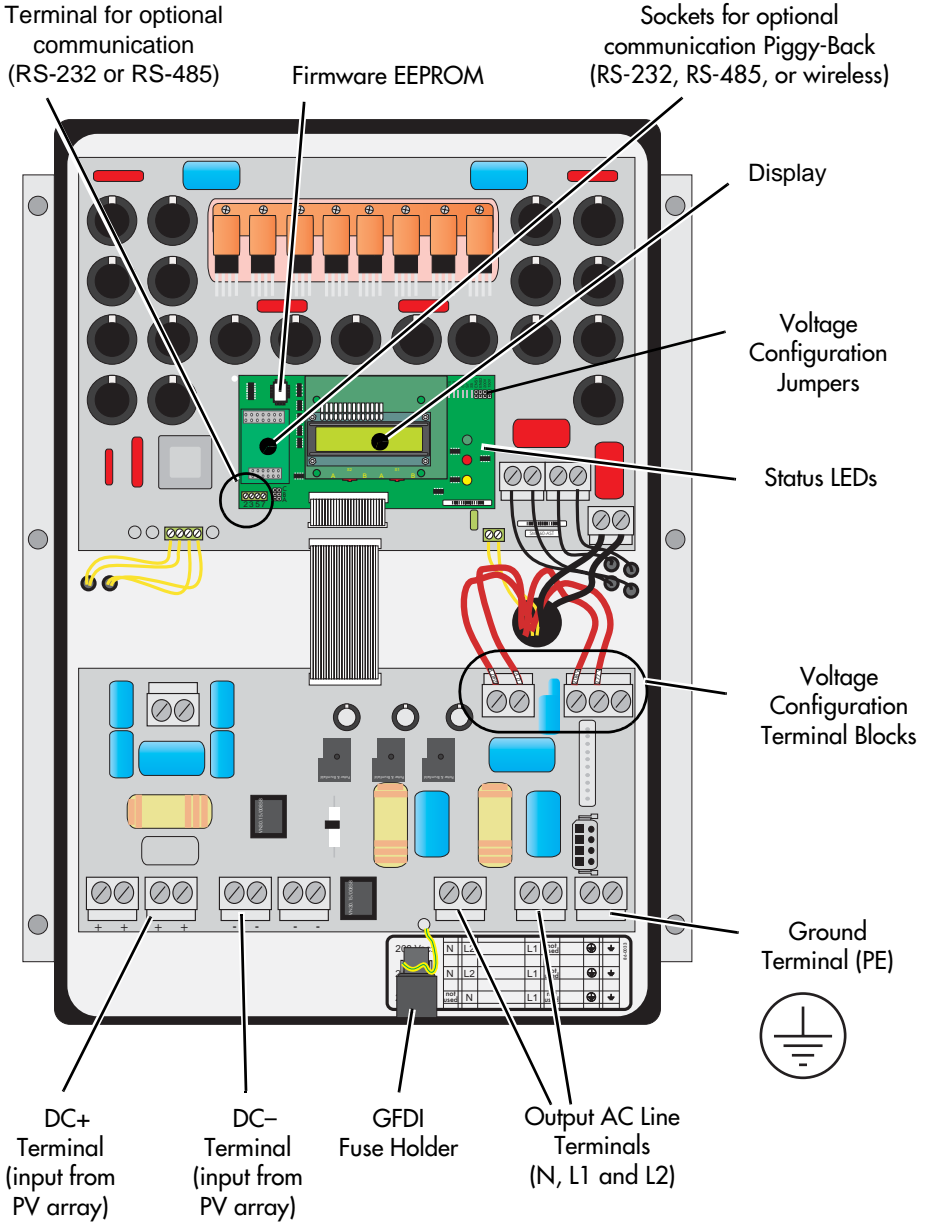

Figure 4-1 Sunny Boy 6000U Internal Components

The Sunny Boy 6000U may be easily configured for the different grid types commonly found in the U.S. The SB6000U is compatible with:

- 208 V AC output
- 240 V AC output ("split-phase")
- 277 V AC output

The SB6000U comes from the factory pre-configured for utility interconnection at 240V AC. The SB6000U may be reconfigured for other voltages by following the steps below and referring to Figure 4-2.

Configuring the Input Voltage

There are four wires coming into the main cabinet through a grommet. Each wire is labeled with its corresponding voltage and is connected to one of the two large terminal blocks located just below the grommet. Refer to Figure 4-2 and follow the instructions below:

1. The input voltage setting is determined by the jumper that is connected to the left terminal block. See Figure 4-2 (1). The SB6000U comes from the factory configured for connection to a 240V system. If the system is 240V, no adjustment is necessary.
2. If adjustment is necessary, choose the wire with the correct voltage for your application from the right terminal block (3) and connect it to the left side of the left terminal block.
3. **Do not** remove the wire in the left terminal block labeled 0V (2). It remains connected to the right side of the left terminal block in all configurations.
4. All unused wires connect to the right terminal block (3).

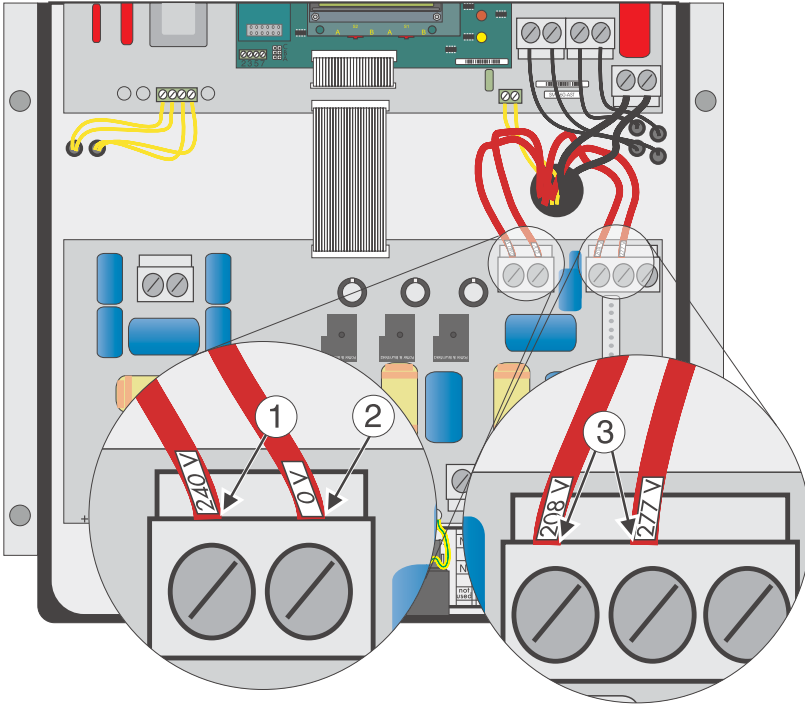

Figure 4-2 Input Voltage Wiring Terminals

If the SB6000U is configured for the incorrect transformer voltage, (e.g. the inverter is configured for 240V and then connected to a 208V grid), the SB6000U will display the following error message:

**Disturbance
XFMR**

If this error message is encountered, recheck the input voltage configuration and confirm that it is set properly.

Automatic Grid Voltage Detection

The SB6000U is designed to automatically detect which grid voltage it is feeding. Depending upon the voltage and phase angle between L1-N and L2-N, the inverter will determine if it is connected to a 208 V, 240 V or 277 V grid. Table 4-1 lists the voltage and frequency limits for the AC connection.

Table 4-1 Voltage and Frequency Limits for the AC Connection

Voltage Range for 208 V nominal, line to line	183 V - 229 V
Voltage Range for 240 V nominal, line to line	211 V - 264 V
Voltage Range for 277 V nominal, line to neutral	244 V - 305 V
Frequency Range	59.3 Hz - 60.5 Hz

If the utility system has a neutral, the local authority having jurisdiction (AHJ) may require that the neutral be connected to the inverter. Follow the steps to properly configure the utility and neutral in the SB6000U.

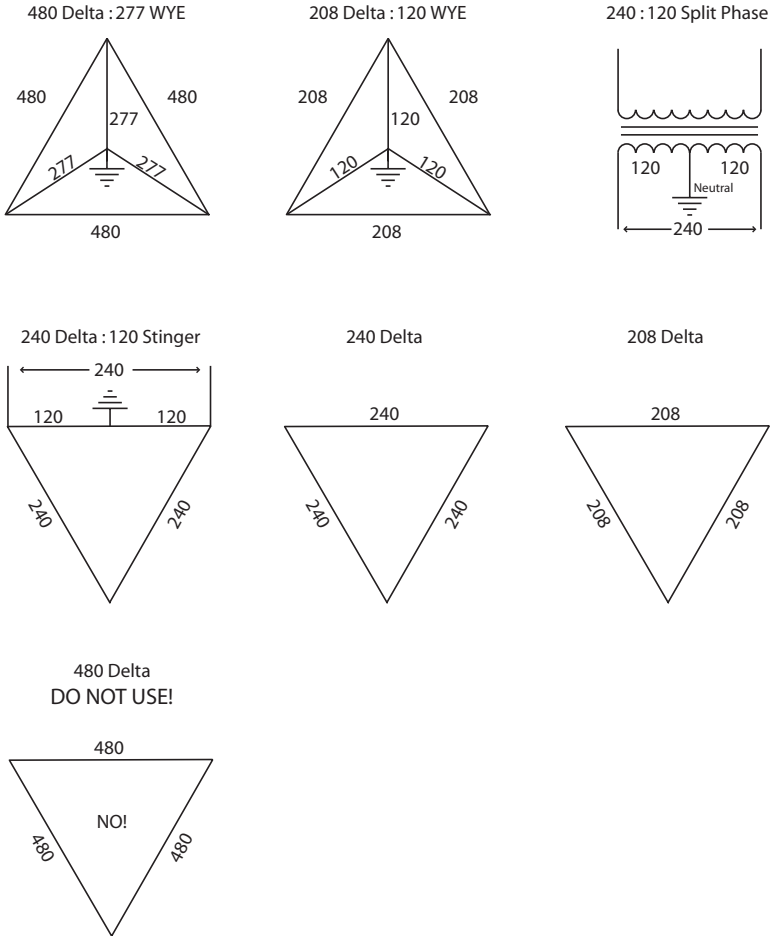

Figure 4-3 Common Utility Voltage Configurations

Figure 4-3 above illustrates commonly used transformer types. Remember, when connecting the SB6000U to the utility, the phase relationship is not important, but the **voltage** must be compatible.

Utility Configuration Jumpers

The utility configuration jumpers allow the SB6000U to be connected to transformers where the neutral is not present, such as the 208V and 240V Delta, shown in Figure 4-3 above. Refer to Figures 4-4 and 4-5 for a description of jumper settings.

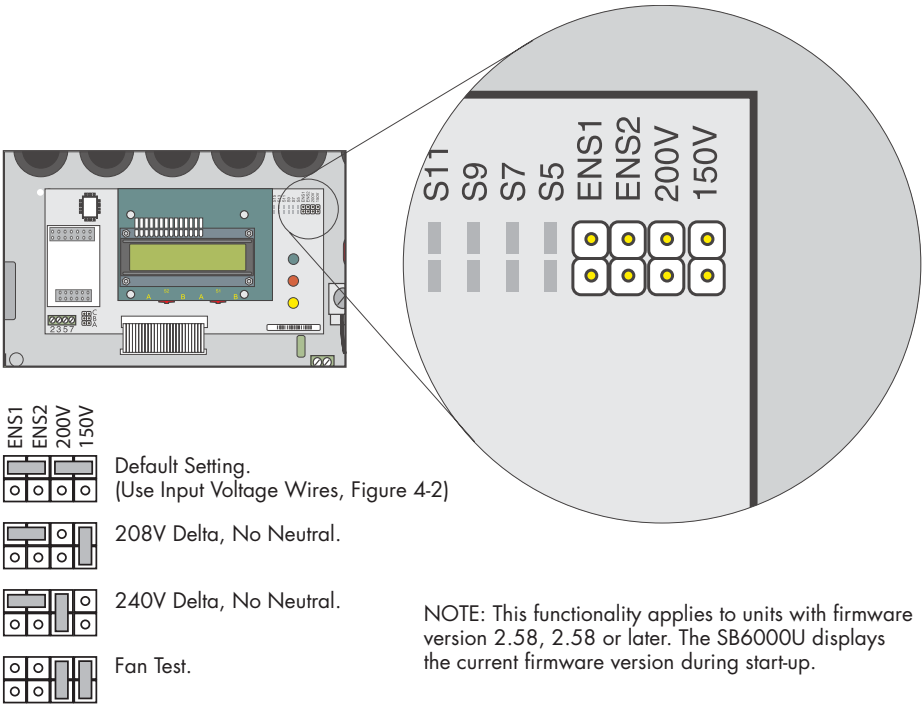

Figure 4-4 Utility Configuration Jumpers

240 Delta : 120 Stinger

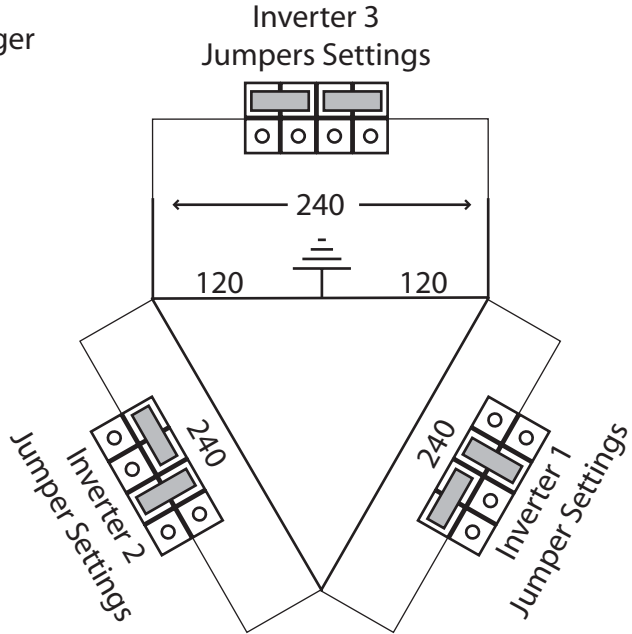

Figure 4-5 Utility Configuration Jumper Examples

Figure 4-5 above illustrates the proper jumper settings when connecting to a 240 Delta: 120V Stinger type transformer. Note the order in which inverters are connected to the phases.

Section 5: Wiring the SB6000U

This section provides step-by-step procedures and other information required for wiring the Sunny Boy 6000U to the PV array and the utility grid. To complete the installation in a safe and efficient manner, complete the steps in the order that they appear.



WARNING: Before connecting or operating the SB6000U, read all of the instructions, cautions, and warnings on the SB6000U, the PV array and in this *Installation Guide*.



WARNING: You must connect the wires that carry the AC voltage from the SB6000U to the utility grid and the wires that carry the DC voltage from the PV array to the SB6000U in the order described in the procedures in this section. Deviating from these procedures could expose you to lethal voltage that can cause serious injury.



WARNING: Always turn OFF all breakers and switches in the PV system before connecting any wires to or disconnecting any wires from the SB6000U.



WARNING: Always connect the wires to the SB6000U in the following sequence:

1. De-energize all energy sources by opening all AC and DC disconnects and/or breakers.
2. Connect wires from the AC breaker to the AC disconnect switch.
3. Connect wires from the AC disconnect to the SB6000U.
4. Connect the PV wires to the DC disconnect.
5. Connect the DC disconnect wires to the SB6000U.
6. Turn the AC switches and/or breakers ON.
7. Turn the DC switches and/or breakers ON.

To disconnect the SB6000U, first turn OFF all AC disconnects and then all DC disconnects. The AC system should always be disconnected before the DC system. After the SB6000U is de-energized, disconnect the wiring in the reverse order from above.



WARNING: Always wait a minimum of 5 minutes for stored potentials in the SB6000U to discharge completely before opening the enclosure.



WARNING: All electrical installations must be done in accordance with all local electrical codes and the National Electrical Code (NEC), ANSI/NFPA 70.



WARNING: Before connecting the Sunny Boy 6000U to the electrical utility grid, contact the local utility company. This connection must be made only by qualified personnel.

The DC input from the PV array (via the DC disconnect enclosure) and the output to the AC utility grid connect to the inverter inside the SB6000U's case. The internal AC and DC wiring terminals accept a maximum wire size of #6 AWG. Knockouts are provided on the bottom of the SB6000U near each of the terminals for the wires to enter the case, see Figure 5-1.

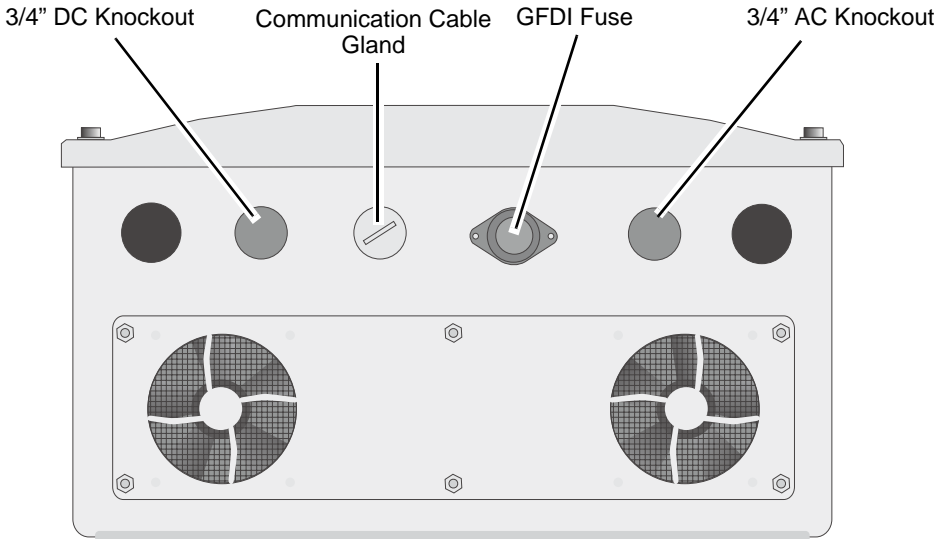

Figure 5-1 Bottom View of the Sunny Boy 6000U Showing 3/4" Wiring Knockouts



CAUTION: All knockouts are sized for $3/4$ -inch rigid conduit (EMT). **DO NOT** enlarge any of these holes, as this is a violation of UL requirements and will void the SMA warranty.

Refer to the table below for the appropriate torque values.

Terminal	in. lbs.	nm.	Wire Size
AC & DC Terminal Blocks	18	2	4 - 16 AWG

Wiring the AC Output

This subsection provides complete, step-by-step procedures for wiring the AC output from the SB6000U to the utility grid.

AC Connection Requirements



WARNING: All electrical installations must be done in accordance with all local electrical codes and with the National Electrical Code (NEC), ANSI/NFPA 70. Use #6 AWG (maximum), 90 °C (194 °F), copper wire for all AC wiring connections to the SB6000U. Voltage drop and other considerations may dictate that larger size wires be used.



WARNING: The National Electrical Code (NEC) states that the inverter must be connected to a dedicated circuit, and that no other outlets or devices can be connected to the same circuit. See NEC Section 690-64(b)(1). The NEC also imposes limitations on the size of the inverter and the manner in which it is connected to the utility grid. See NEC Section 690-64(b)(2).



WARNING: To reduce the risk of fire, connect only to a circuit provided with 40 amperes maximum branch circuit overcurrent protection in accordance with the National Electric Code, ANSI/NFPA70.

The diagram in Figure 5-2 and Figure 5-3 shows the potential losses in AC wires with respect to the cross-sectional area of the cable and the length of the cable. Use the following tables to determine the best wire size to use for your particular installation.

Percent voltage drop for 208 V AC and 240 V AC service

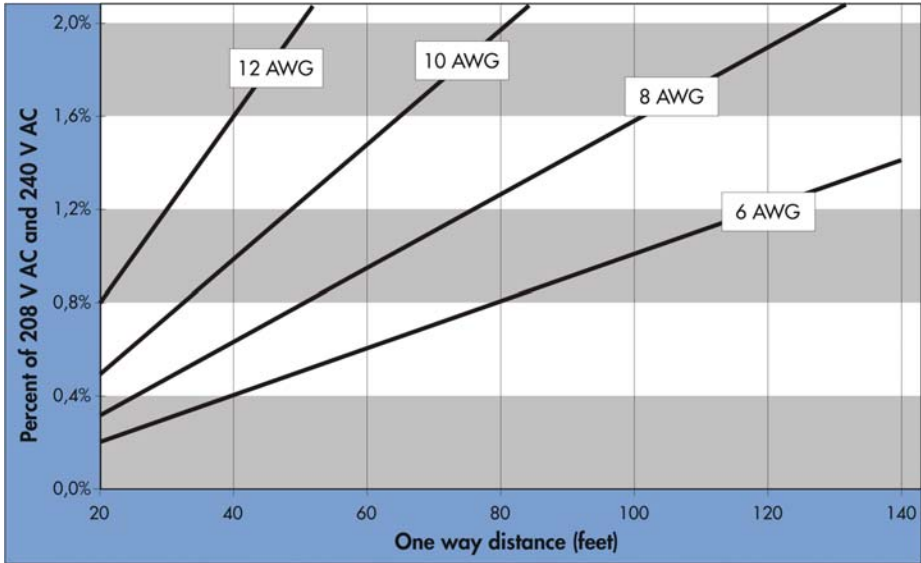

Figure 5-2 Energy Losses in Various Wire Sizes and Wire Lengths

Percent voltage drop for 277 V AC service

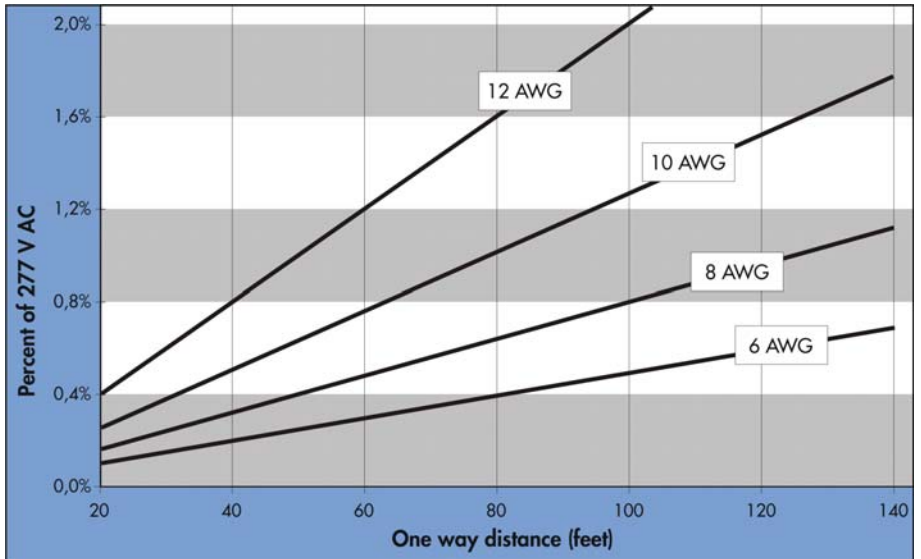

Figure 5-3 Energy Losses in Various Wire Sizes and Wire Lengths

The SB6000U is designed to automatically detect which grid voltage it is feeding. Depending upon the voltage and phase angle between L1-N and L2-N, the inverter will determine if it is connected to a 208 V, 240 V or 277 V grid. Table 5-1 lists the voltage and frequency limits for the AC connection.

Table 5-1 Voltage and Frequency Limits for the AC Connection

Voltage Range for 208 V nominal, line to line	183 V - 229 V
Voltage Range for 240 V nominal, line to line	211 V - 264 V
Voltage Range for 277 V nominal, line to neutral	244 V - 305 V
Frequency Range	59.3 Hz - 60.5 Hz

See Section 4 for information on configuring the inverter jumpers for the utility type of the installation.

Connecting the AC Wires

Use the following procedure to connect the AC wires to the SB6000U:



WARNING: You must connect the wires that carry the AC voltage from the SB6000U to the utility grid in the order described in this procedure. Deviating from this procedure could expose you to lethal voltages that can cause serious injury and/or death.

1. Turn OFF the main breaker in the main utility breaker box.
2. Remove interior breaker panel cover.
3. If you are replacing an existing inverter, disconnect the wires for the AC line you are working with in the breaker box.
4. Install a 3/4-inch conduit fitting in the SB6000U's AC wiring knockout (the knockout on the right side of the SB6000U, as shown in Figure 5-1). Fasten the conduit fitting on the inside of the SB6000U with the appropriate locknut.
5. Install 3/4-inch conduit between the main breaker box and the SB6000U's AC wiring knockout.
6. Pull the AC wires through the conduit from the interior of the breaker box to the interior of the SB6000U.



Note: Refer to Figure 5-4 on page 5-7 for steps 7 through 10.



CAUTION: Avoid using wire nuts to join any wires together or to make any connections anywhere in the PV system. Wire nuts are a frequent cause of unreliable, resistive connections, and ground faults.

7. Connect the AC equipment-ground wire to the terminal labeled PE in the SB6000U. 
8. For 208/240/277 V connect the L1 (AC line 1 or HOT) wire to the terminal labeled L1 in the SB6000U.
9. For 208/240 V connect the L2 (AC line 2) and N (AC line N) wire to the terminal labeled L2 and N in the SB6000U. For 277 V connect the N (AC line N) wire to the terminal labeled N in the SB6000U. NOTE: For 277 V the L2 terminal is not used.
10. Connect the wires and tighten to a torque of 18 in-lb.
11. Verify that all connections are correctly wired and properly torqued.

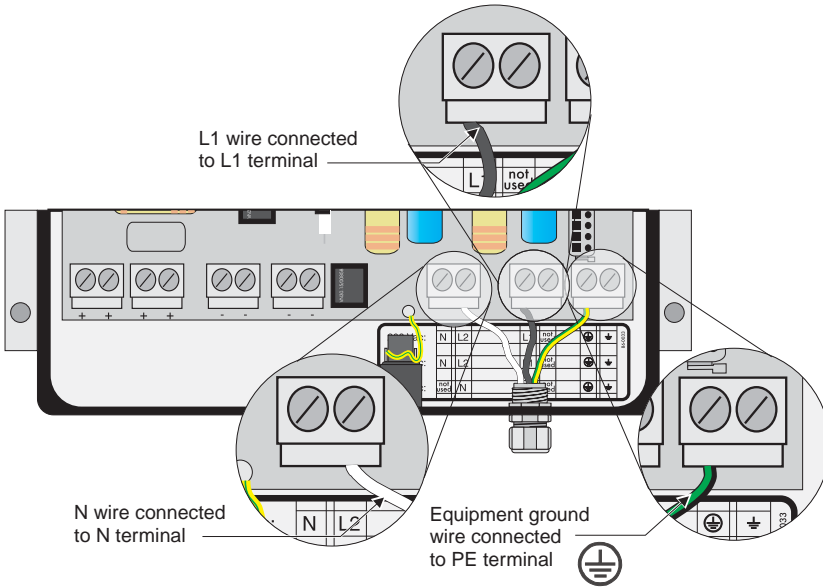

Figure 5-4 AC Connection Terminals for 277 V

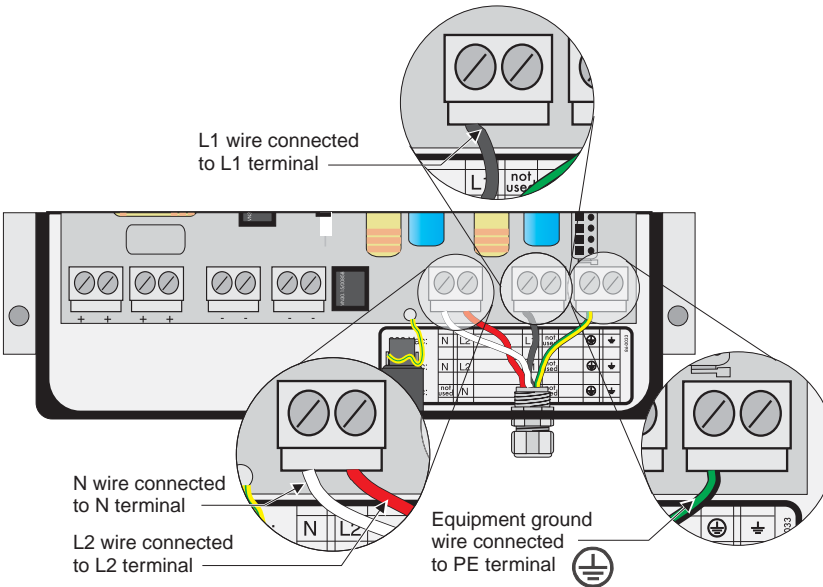

Figure 5-5 AC Connection Terminals for 208 V and 240 V

Wiring the DC Input

This subsection provides procedures for wiring the DC input from the PV array (via the DC disconnect enclosure) to the SB6000U. Figure 5-6 shows a simplified wiring diagram of a PV system.

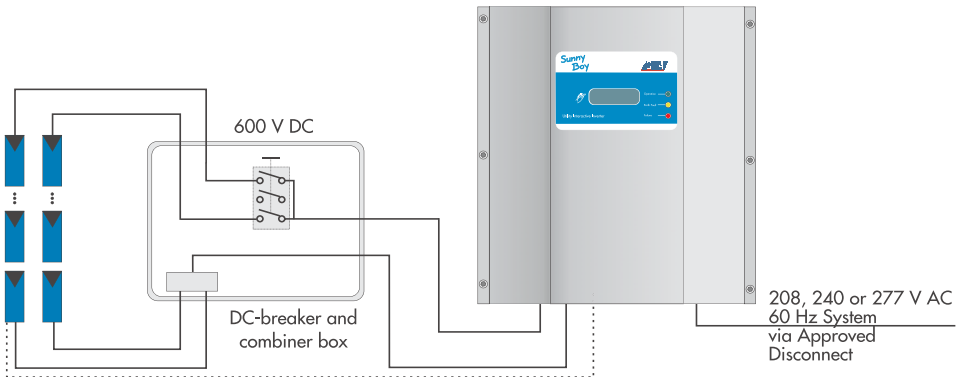

Figure 5-6 Simplified Electrical Wiring Diagram of a PV System

DC Connection Requirements



WARNING: All electrical installations must be done in accordance with all local electrical codes and with the National Electrical Code (NEC), ANSI/NFPA 70. Use #10 AWG (min.), 90 °C (194 °F), copper wire for all DC wiring connections to the Sunny Boy. Voltage drop and other considerations may dictate that larger size wires be used.



WARNING: The DC disconnect for the inverter must have a minimum rating of 600 VDC and 30 A continuous.



Note: Use the online SMA string size calculator at www.sma-america.com to determine the correct string configuration (see Figure 5-9). To navigate to the string size calculator, click “Solar Design Tools / String Sizing” in the menu bar at the top of the home page.



Note: Series fusing may be required depending on the type of PV module used in the system. See NEC 690.9.

DC Input Grounding

The Sunny Boy 6000U comes from the factory configured for negative ground systems. Certain types of PV modules may require that the positive terminal be grounded instead of the negative terminal. To configure the SB6000U for positive ground, move the fuse (1) and change the jumper position (2) as show in the following illustrations.

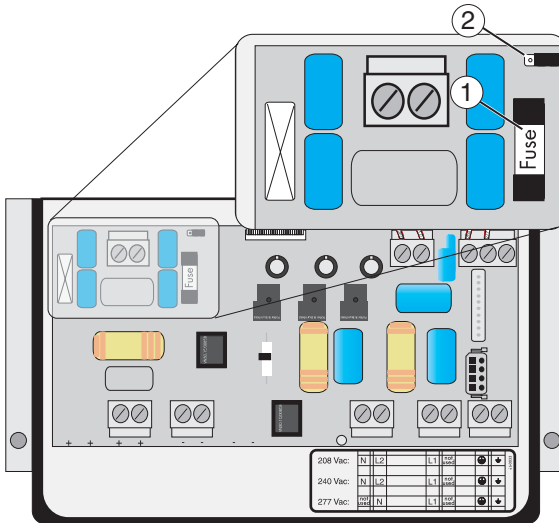

Figure 5-7 GFDI Fuse and Jumper Settings for Negative Ground

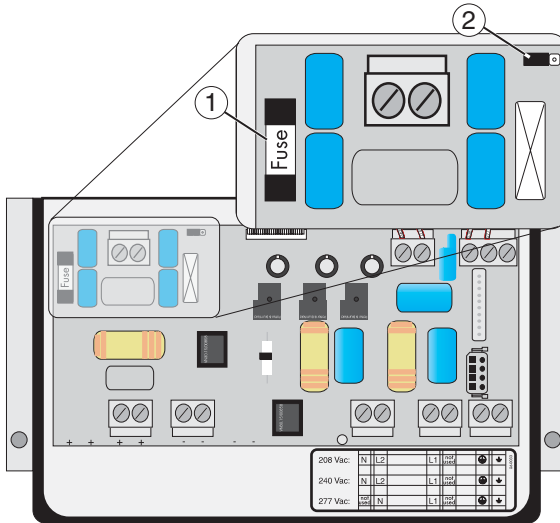

Figure 5-8 GFDI Fuse and Jumper Settings for Positive Ground

SMA America USA - Microsoft Internet Explorer

Address: http://www.sma-america.com/stringstring.asp

For an explanation of any particular entry definition click on the actual term for a glossary.

Design Options

Please Select an Inverter: SWR 2500U (208) | Please Select a PV Manufacturer: ASE (RWE Schott Solar) | Please Select a PV Module: Please Select

Inverter Data

Design Irradiance (W/m²): | Pac: | Pdcmax: | Idc Max: | Vdc Max: | Vmppt Max: | Vmppt Min: | Vmin:

Module Data

Module Power (W): | Voc (V): | Vmp (V): | Isc (A): | Imp (A): | Temperature Coefficient of Voltage: | Temperature Coefficient of Current: | Temperature Coefficient of Power:

Mounting Method

Please select the mounting method for the array: Mounted flat against the roof

Temperature Data

If you do not know the hottest and coldest ambient temperatures that you should select for your area please enter the 5-digit postal ZIP code of the address of the installation here: and then Click Here

Select the coldest record low ambient temperature when sunlight will be on the array: 32°F | Select the hottest average high ambient temperature when sunlight will be on the array: 104°F | Imperial units: | Metric units:

Results

1 String	2 String	3 String	4 String	5 String

Get Sizes | Clear

* Some derating possible ** Some derating likely with out adequate air flow *** Install a Sunny Breeze Kit to prevent derating

Figure 5-9 Online String-Configuration Calculator at www.sma-america.com

Connecting the DC Wires



WARNING: You must connect the wires that carry the DC voltage from the PV array to the SB6000U in the order described in the following procedure. Deviating from this procedure could expose you to lethal voltages that can cause serious injury and/or death.



WARNING: PV arrays are energized when exposed to light. Use safe working practices when working on PV arrays.



WARNING: Always turn OFF *all* AC and DC breakers and switches in the PV system and wait a minimum of 5 minutes for the SB6000U to completely discharge before connecting any wires to the SB6000U or disconnecting any wires from the SB6000U. Failure to do so could expose you to lethal voltages that can cause serious injury and/or death.



CAUTION: *Verify the polarity and the open-circuit voltage from the PV strings before you connect the DC wires to the SB6000U. Applying an open-circuit DC-input voltage that exceeds the maximum DC-input-voltage range will cause irreversible damage to the SB6000U and void the warranty! Always configure the DC-input-voltage range correctly before connecting the DC-input wires from the PV array to the SB6000U. Use the online SMA string size calculator at www.sma-america.com (see Figure 5-7) to determine the correct string configuration.*

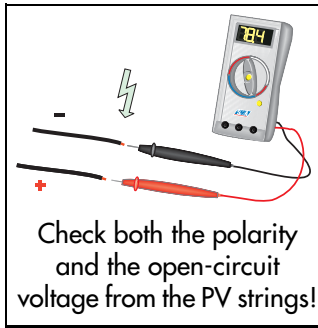

Use the following procedure to connect the DC wires to the *SB6000U*:

1. Verify that the AC breaker is OFF.
2. Verify that the DC disconnect is open in the DC disconnect enclosure.
3. Install a 3/4-inch conduit fitting in the *SB6000U*'s DC wiring knockout. The DC knockout is the one farthest to the left on the bottom of the *SB6000U*, as shown in Figure 5-1 and Figure 5-10. Fasten the conduit fitting on the inside of the *SB6000U* with the appropriate locknut.
4. Install 3/4-inch conduit between the DC disconnect enclosure and the *SB6000U*'s DC wiring knockout.



Note: Refer to Figure 5-10 for steps 5 through 7.

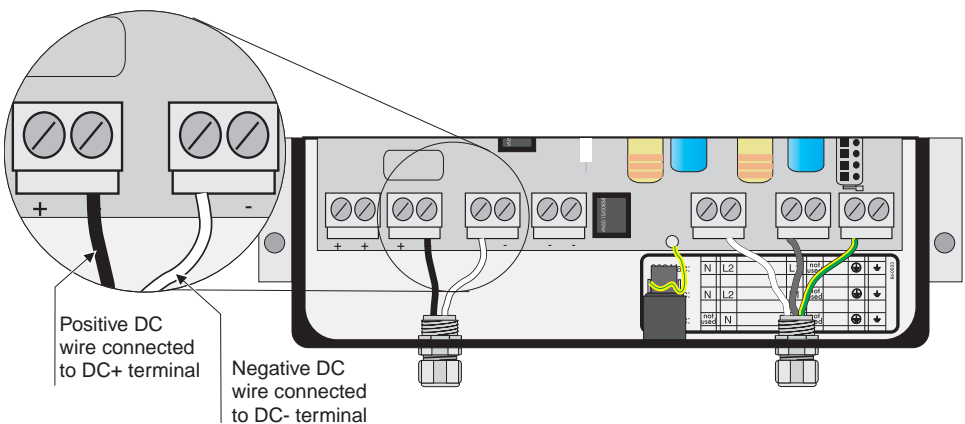

Figure 5-10 DC Connection Terminals

5. Pull the DC wires from the DC disconnect through the conduit into the interior of the SB6000U.
6. Connect the positive DC wire to the terminal labeled DC+ in the Sunny Boy.
7. Connect the negative DC wire to the terminal labeled DC– in the Sunny Boy.



Note: The SB6000U has provisions for either one or two PV strings. The positive and negative terminal blocks each have two positions, so two pairs of DC-input wires can be connected in parallel.



CAUTION: Avoid using wire nuts to join any wires together or to make any connections anywhere in the PV system. Wire nuts are a frequent cause of unreliable connections, resistive connections, and ground faults.

8. Connect the positive and negative DC wires to the appropriate terminals in the DC disconnect enclosure.
9. Connect the DC equipment ground wire to the terminal labeled PE in the SB6000U.
10. Torque all wires to 18 in-lb.
11. Verify that all connections are correctly wired and properly torqued.

Communication Wiring

Various data-communication options are available for the Sunny Boy 6000U. These options are provided in the form of accessory Piggy-Back modules that can be installed and connected either at the time the inverter is installed or at any time thereafter. These modules are not included with the SB6000U. Please contact SMA America for information. Refer to the instructions included with the communication module for installation procedures.

The following subsections provide instructions for connecting the various communication cables between a SB6000U with a communication module and a personal computer (PC). The connection of a SB6000U to a Sunny Boy Control or a Sunny Beam PV plant monitoring unit is shown in those respective manuals.

RS-232 Communication

RS-232 is a communication standard for bidirectional transmission of data between a Sunny Boy and a PC. Only one Sunny Boy can be connected with an RS-232 serial cable to a PC.

Requirements for RS-232 Communication:

- The Sunny Boy 6000U must be equipped with an RS-232 Piggy-Back communication module.
- The cable should be no longer than 15 meters (50 ft.) Use the cable type specified in the RS-232 Tech Note on www.sma-america.com.
- RS-232 cables are available from SMA America.
- Conduit may be required for communication wiring, per local electrical code requirements.

Connecting an RS-232 Cable

Use the following procedure to install an RS-232 data-communication network:

1. Run the communication cable from the location of the PC to the *SB6000U*.
2. Verify that the PC has a serial port and that it is activated in the BIOS and the operating system.
3. Attach the appropriate DB-9 connector to the end of the cable near the PC. See Table 5-2 and Figure 5-11 for the pin assignments for the serial connector. Record the wire color used for each of the pins listed in Table 5-2.
4. Route the other end of the cable into the *SB6000U* through the communication-knockout on the bottom of the *SB6000U* (see Figure 5-1).
5. Referring to Table 5-2 and Figure 5-11 and your record of the wire colors used for each pin from step 3, connect the appropriate wires to the communication terminal block in the *SB6000U*.
6. Connect the cable shield to the *SB6000U*'s case. Do NOT connect the cable shield to the PC's DB-9 connector. The shield must remain floating at the PC.



CAUTION: All AC and DC power should be off when connecting the communication wiring to the SB6000U.

Table 5-2 RS-232 Pin Assignments

Communication Terminal Block (SB6000U)	Signal Name	9-Pin Serial-Port Connector (PC)	25-pin Serial-Port Connector (PC)
Case	Shield	Case	Case
2	RxD (Output from Sunny Boy)	2	3
3	TxD (Input to Sunny Boy)	3	2
5	GND	5	7

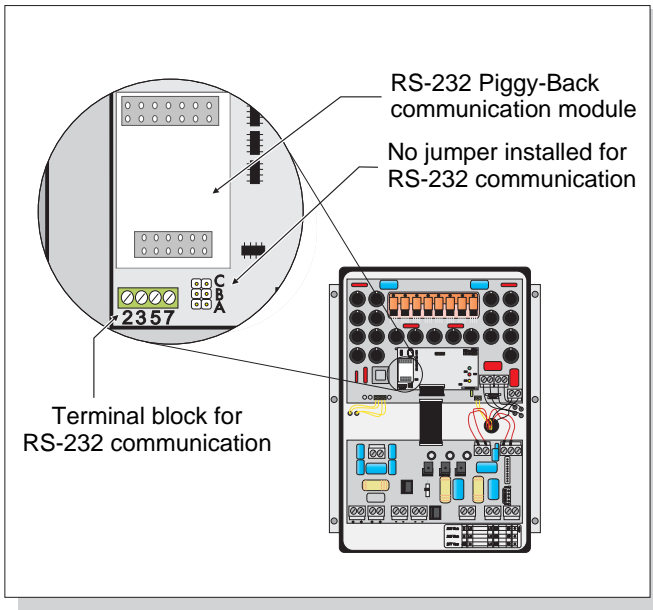
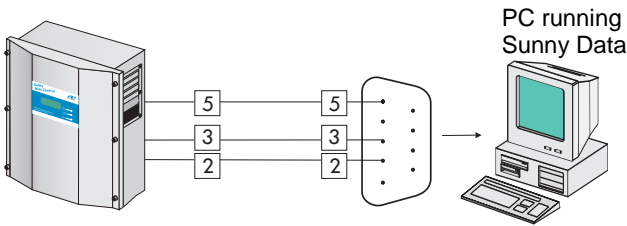

Figure 5-11 Connecting a SB6000U to a PC with an RS-232 Cable

RS-485 Communication

RS-485 is a communication standard for bidirectional transmission of data between one or more Sunny Boy inverters and a PC.



Note: All Sunny Boy inverters are capable of RS-485 communication. You can mix different Sunny Boy models on the RS-485 communication bus.

Requirements for RS-485 Communication:

- The Sunny Boy 6000U must be equipped with an RS-485 Piggy-Back communication module.
- The cable should be no longer than 1200 meters (4000 feet) with a common shield, and a wire size no smaller than 24 AWG. Use the cable type specified in the RS-232 Tech Note on www.sma-america.com.
- RS-485 cables are available from SMA America.
- Conduit may be required for communication wiring, per local electrical code requirements.

Connecting an RS-485 Cable

Use the following procedure to install an RS-485 data-communication network:



Note: The following steps describe how to connect one or more Sunny Boy inverters to an RS-485 bus. For more information on connecting more than one inverter to an RS-485 bus, please see “Technical Note: RS-485 Communication” in the Tech Updates section of our web site at www.sma-america.com

1. Connect the three wires of the RS-485 cable to terminals 2, 5, and 7 of the communication terminal block as shown in Figure 5-10. Record the wire color used for each of the terminals.
2. Connect the shield of the cable to the *SB6000U*'s case. Do NOT connect the cable shield to the PC's DB-9 connector. The shield must remain floating at the PC.
3. Install a jumper in position A, the bottom set of pins on the communication jumper block, to set it for termination.



Note: The termination of the other end of the RS-485 cable will depend on what type of device you're connecting to. For detailed information, please see the Tech Updates section of our web site at www.sma-america.com There you will find technical information on all of the Sunny Boy communication options.

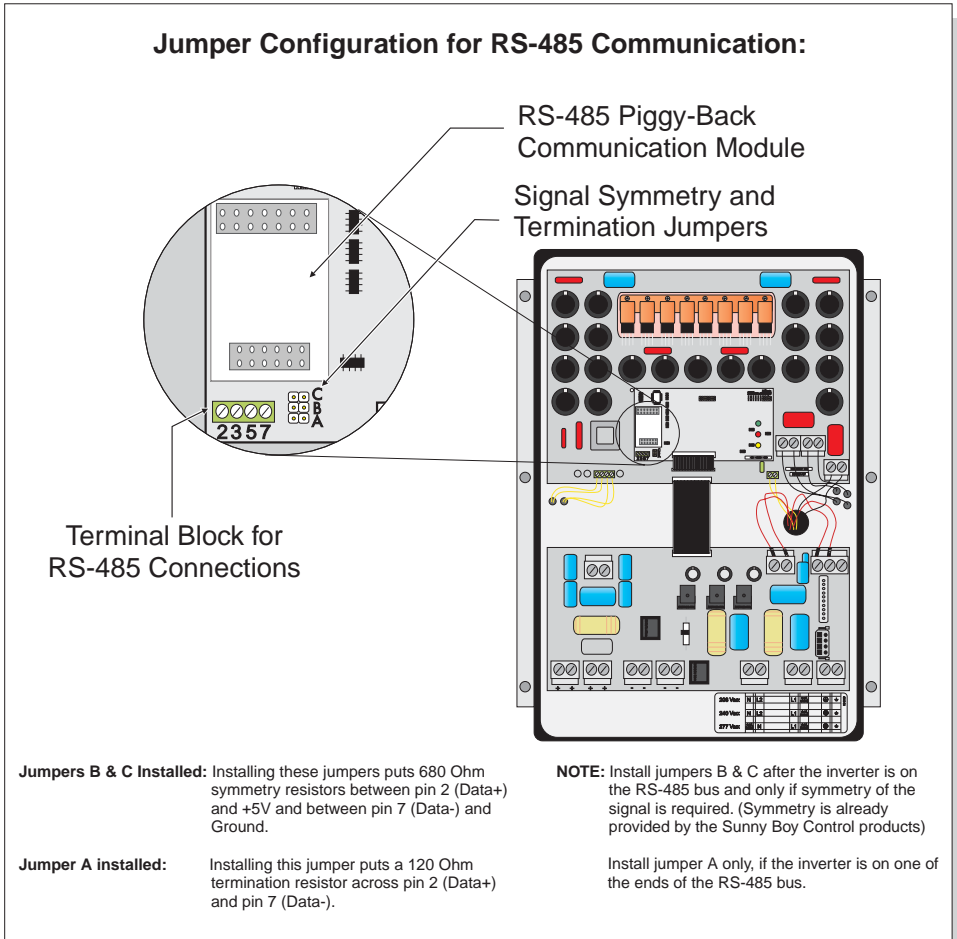

Figure 5-12 Detail of RS-485 Termination and Jumper Settings

RS-485 Pinouts

2 - A (+) (Data+)

7 - B (-) (Data-)

5 - SR (Signal Ref.)

Replacing the Cover

When you have finished connecting the AC-output wires, the DC-input wires, and the communication cables, re-check all your connections to ensure that everything is in the right place and that all connections and knockout fittings are secure and properly torqued. Check all of the knockout fittings on the bottom of the *SB6000U* to ensure that they provide a weather-tight seal.



WARNING: Never install the *SB6000U* during rain or very damp conditions. Because the *SB6000U* is completely sealed, you must be sure no moisture is trapped inside the enclosure when securing the lid.



CAUTION: Be careful not to misplace the screws or the lock washers that attach the cover to the case, as all six screws and lock washers are required to ensure that the cover is grounded properly and is fully sealed to the case. Handle the cover carefully, as even minor damage to the cover could result in an inadequate seal between the cover and the case, thus allowing moisture to enter the case and damage the sensitive electronic components.

Use the following procedure to replace the cover on the *SB6000U*:

1. Check wire routing to ensure that no wires can interfere with proper sealing of the cover and that no pressure will be exerted on the connections when the cover is replaced.
2. Locate the six screws and lock washers you removed to take the cover off the *SB6000U*. Make sure you have all six screws and lock washers, as all of this hardware is necessary to ensure proper grounding and a weather-tight seal.
3. Check the seal on the inside of the cover to ensure it is undamaged and in the correct position.
4. Carefully position the cover on the front of the *SB6000U* so that the six holes in the cover are aligned correctly with the six threaded holes in the case.



Note: Be sure when reinstalling the six screws that the lock washers are installed correctly. The teeth of the washers should face towards the **LID**.

5. While holding the cover in place, carefully insert the six screws with lock washers through the holes in the cover into the threaded holes in the case and turn them until they are finger-tight. Be careful not to cross-thread any of the screws. Do not use power tools to start the screws.
6. Verify that the cover is in the correct position and that the seal is in place between the case and the cover.
7. Tighten the cover screws to a torque of 70 in-lbs. (8 Nm).

Section 6: Commissioning



WARNING: Follow the steps in the commissioning procedure in the order they are presented. Deviating from these procedures could expose you to lethal voltages that can cause serious injury and/or death.



WARNING: Never insert the GFDI fuse into the SB6000U without the fuse holder base. Latent voltage may still be present and electric shock may result.



CAUTION: Follow the steps in the commissioning procedure in the order they are presented. Deviating from these procedures could cause irreversible damage to the SB6000U and void the warranty.

All Sunny Boy inverters have a sophisticated system for detecting and responding to PV array ground faults as required by NEC Section 690.5. The PV array normally operates in a grounded configuration. The array's negative conductor is connected to the grounding system inside the inverter as a part of the UL1741 Listed ground-fault detection system. The GFDI protection is active whenever there is sufficient DC voltage to turn on the LCD in the SB6000U.

To commission the SB6000U, follow these simple instructions:

- 1) Connect the grid voltage to the SB6000U by switching on the main AC circuit breaker in the main utility panel.
- 2) Making sure any covering placed over the PV array is removed, switch the DC disconnect to the on position. If there is sufficient sunlight available, the SB6000U will enter the "Wait" mode at this time and the green LED will begin to blink.
- 3) If no AC faults are detected, the "Wait" mode will end after 10 seconds and the green LED will stop blinking, remain on and the SB6000U will begin to operate normally.



Note: If there is a ground fault in the array, the "EarthCurrentMax" error message will be displayed and the GFDI fuse may clear. If this error message is encountered, switch off the DC and AC disconnects to the SB6000U and troubleshoot the array.



Note: If the SB6000U is not operating as expected after the commissioning procedure has been completed, refer to Section 7: Displays and Messages and to Section 8 for troubleshooting assistance.



Note: If there is adequate solar irradiation and the resulting PV input voltage is greater than 300V DC, the SB6000U will automatically begin feeding power to the utility grid.



Note: The SB6000U operates from the power produced by the PV array and is designed for minimal internal DC-power consumption. The maximum power that the Sunny Boy 6000U will consume in normal operation is 7W.



Note: Anytime the AC power is disconnected from the inverter, either manually or as a result of an AC disturbance, the inverter will wait 5 minutes after the AC power has been restored to reconnect. When servicing the inverter, always disconnect the DC first, then the AC.

Section 7:

Displays and Messages

Each Sunny Boy inverter comes equipped with three LED status indicators. (Shown in Figure 7.1) This allows the user to determine the operating mode of the inverter at a glance. The basic definitions of the indicator lights are as follows:

The **green** LED indicates normal operation of the inverter.

The **red** LED indicates the status of the GFDI fuse, located in the holder on the underside of the inverter. If this LED is lit, the GFDI fuse has cleared or is not present.

The **yellow** LED indicates that there is a fault of some kind, either inside the inverter or somewhere in the PV system. The inverter will not operate until the fault has been corrected. The different error codes and possible causes are addressed later in this section and in Section 8: "Troubleshooting".

The **red** and **yellow** LEDs combined indicate that the inverter has detected a ground fault. The ground fault must be located and cleared and the inverter reset manually. The inverter will not restart automatically after detecting a ground fault. The ground fault may also clear the GFDI fuse.

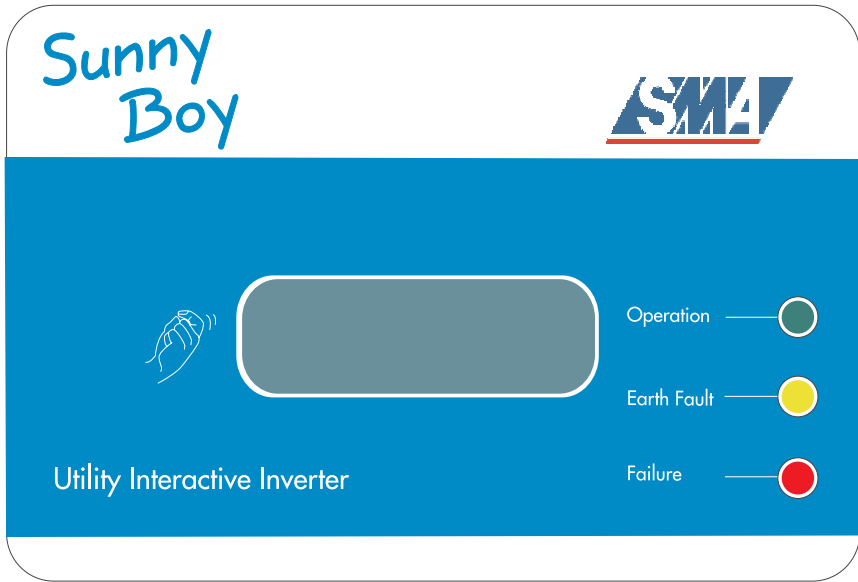
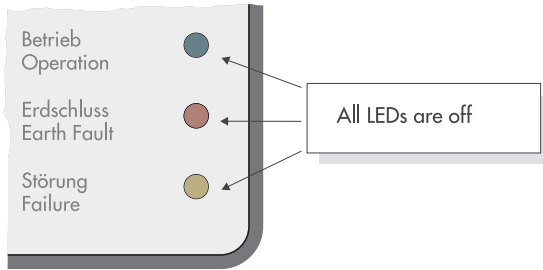

Figure 7-1 The Sunny Boy LED Status Indicator

LED Operation Indicators

Standby (Night)



The inverter is in standby mode because the input voltage is too low for operation.

Initialization

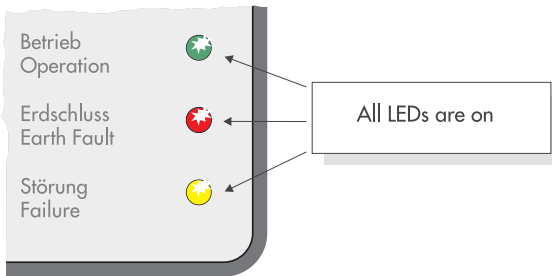

The inverter is initializing. The power from the array is sufficient to initialize control power, but not yet powerful enough to begin normal operation. Data transmission is not possible during initialization.

Occasionally, during inclement weather or low irradiation, the LEDs may all turn on at once and then go off again. This indicates that the inverter is trying to initialize but the power available from the array is not sufficient for normal operation. This is not a malfunction.

Starting

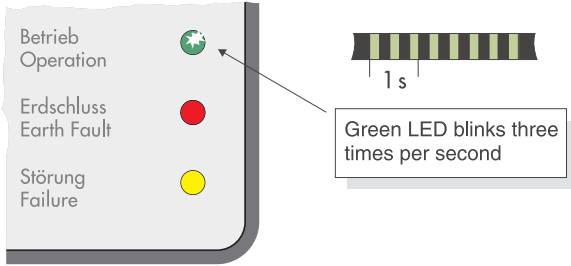

The inverter has sufficient PV power to calibrate its internal systems, but not enough to begin normal operation. Typically, the calibration lasts less than 10 seconds and then the inverter resumes normal operation. PV voltage must remain > PV Start Voltage setting for the period of the P-Start parameter setting. (See Section 8) The inverter will also show this status if it has been manually set to STOP mode.

Waiting

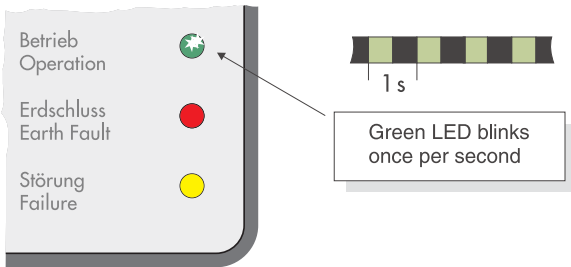

The inverter has determined that there is enough voltage from the array to operate and is checking the condition of the grid prior to connecting to it.



Note: If the inverter fails to connect to the utility grid 3 times in a row, it will wait 10 minutes before the next attempt. In case of a grid failure, the Sunny Boy waits 5 minutes before it tries to reconnect to the grid.

Normal Operation

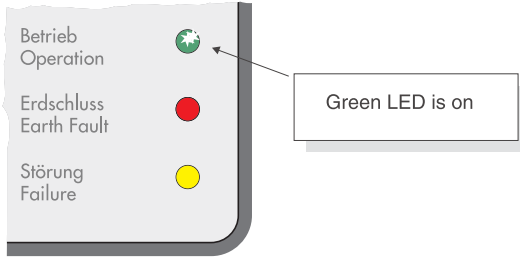

The inverter is feeding the utility grid in either "MPP", "Constant Voltage" or "Turbine" mode.

"MPP" Mode: The SB6000U adjusts the voltage and current from the PV array to obtain the greatest PV output power.

"Constant Voltage" Mode: The voltage from the PV array has been set to a fixed value. This value is set by using the Sunny Boy Control or the Sunny Data software. (The parameter name is "V-Const") This mode is typically used for fuel cell or micro-hydro applications.

"Turbine" Mode: This mode is used for DC rectified motor sources with a dynamic power curve (typically wind turbines). The user can set the magnitude and slope of the curve to match a particular alternator.

Derating

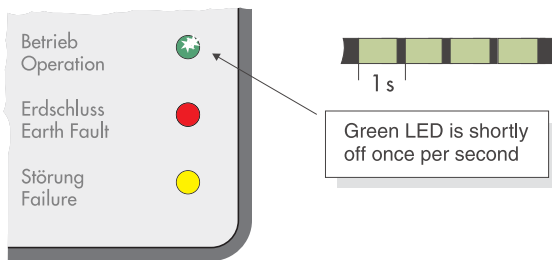

The SB6000U is designed to operate at full rated power up to 45°C ambient. The inverter will continue to operate beyond 45°C and will derate as required to maintain a safe internal component temperature. Unnecessary derating can be caused by blocked fan intakes. For this reason the fan intakes should be inspected often and cleaned when needed.

LED Fault Indicators

Ground Fault

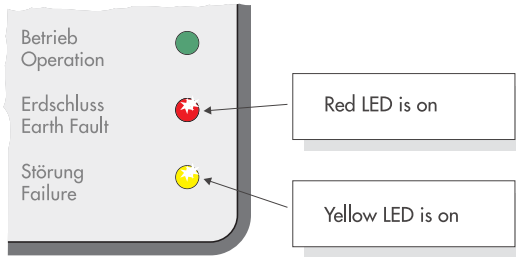

The inverter has detected a ground fault in the PV system and has disconnected from the grid. **The ground fault must be located and fixed before the inverter will resume normal operation.** Refer to Section 8: “Troubleshooting” for information on solving PV array ground faults. (The inverter will not restart automatically)

Cleared GFDI Fuse

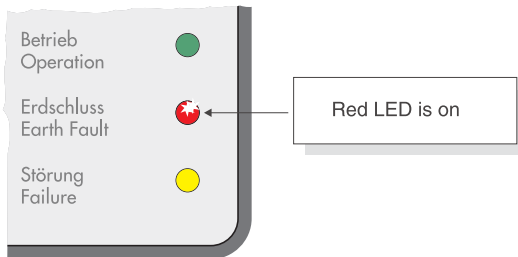

The GFDI fuse located in the fuse holder on the bottom of the inverter has been cleared or is not present. This fuse is used to protect the PV system in the event of an array ground fault. Troubleshoot the PV array for ground faults prior to replacing this fuse.



CAUTION: For continued protection against the risk of fire, replace the GFDI fuse with fuses of the same type and rating only. The SB6000U is shipped with a **Littelfuse KLKD 1 Amp, 600V AC/DC** type fuse.

Control System Fault

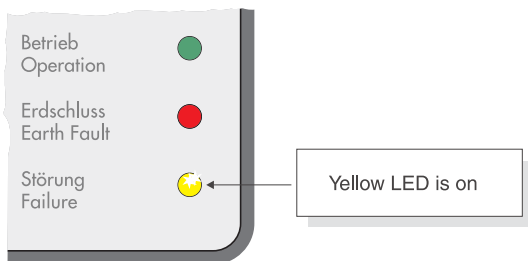

The yellow LED remains lit.

The SB6000U has detected a fault within the internal monitoring systems. When the inverter detects a fault of this kind it will no longer connect to the utility grid. To correct this, the inverter must be serviced by a qualified service technician. Contact SMA America for assistance.

Grid Failure

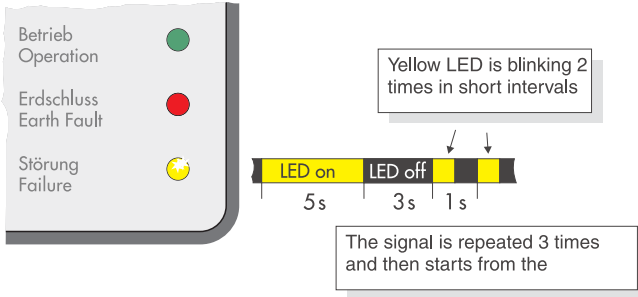

The yellow LED is on for 5 seconds, out for 3 seconds and then blinks twice. The code is repeated 3 times. This code sequence will repeat as long as there is a grid fault condition.

This code can be caused by any of the following conditions:

- Low Grid Voltage (<Vac Min)
- High Grid Voltage (>Vac Max)
- Low Grid Frequency (< fac Min)
- High Grid Frequency (>fac Max)
- Rapid change in grid frequency or voltage

Check the condition of the grid at the AC terminal blocks within the SB6000U. Also inspect the AC disconnect between the Sunny Boy and the grid.



CAUTION: Have the grid connection to the SB6000U checked only by qualified personnel.



WARNING: If opening the SB6000U is required, do so only after disconnecting all sources of power and waiting at least 5 minutes.

High DC Input Voltage

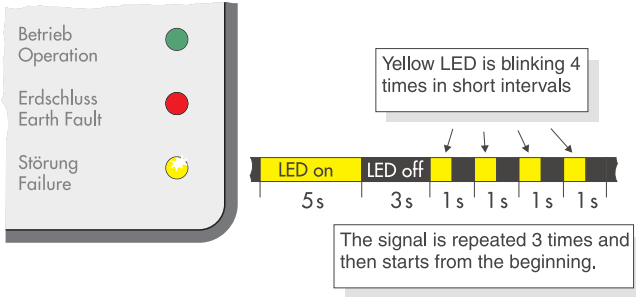

The yellow LED is on for 5 seconds, remains off for 3 seconds and then blinks 4 times. The code is repeated 3 times. If the condition remains the code will continue to be sent.

The inverter has detected a DC input voltage that is too high for safe operation.



WARNING: Disconnect the PV array from the SB6000U immediately. High DC input voltage can permanently damage the inverter. Have the input source checked by a qualified technician.



WARNING: Always test the DC voltage at the DC disconnect switch before energizing the SB6000U.

Inverter Fault

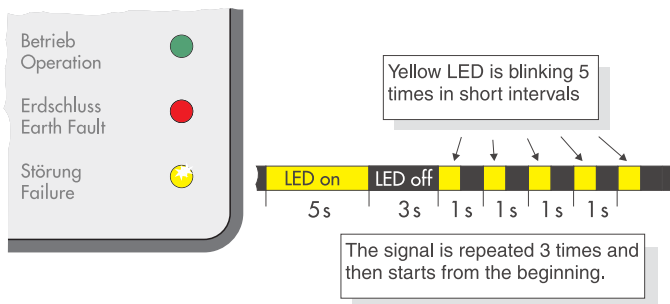

The yellow LED is on for 5 seconds, remains off for 3 seconds and then blinks 5 times. The code is repeated 3 times. If the condition remains the code will continue to be sent.

The inverter has encountered an internal fault that prohibits normal operation and will most likely require servicing.

Contact SMA America for assistance.

Status Messages on the LCD Display

The Sunny Boy 6000U comes standard with the “Sunny Display” LCD in the lid.

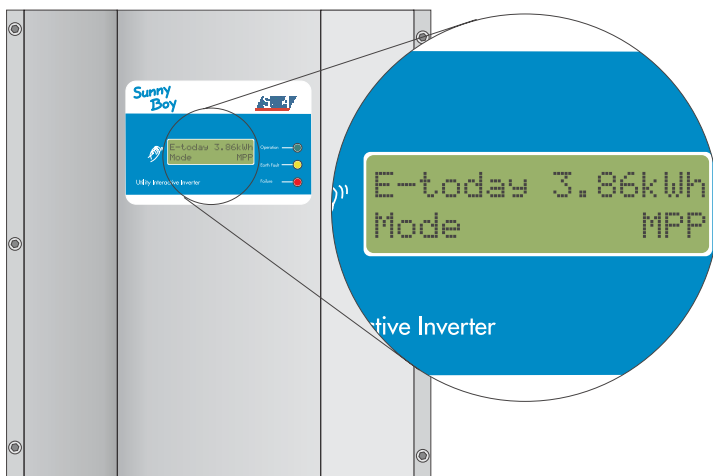

Figure 7-2 SB6000U LCD Display

Activation of the Backlight

The backlight is activated by knocking twice on the lid. Additional knocks will scroll through the display messages.

The backlight shuts off automatically after 2 minutes.

INIT Messages

The following messages are displayed during initialization of the inverter:

Sunny Boy 6000U
WR60UxxE

Sunny Boy Inverter Model #

The installed firmware versions of the control system processor (BFR) and the current regulator processor (SRR) are displayed after 6 seconds.

BFR Version x.xx
SRR Version x.xx

Firmware Version #'s

Operation Messages

The LCD continuously scrolls through all relevant operating data. Each message (MSG) is displayed for 5 seconds, after all messages have been displayed the LCD repeats from the beginning.

MSG #1 "E-Today" (total energy produced on this day) is displayed together with the current operating mode:

E-today	3.86kWh
Mode	MPP

Energy produced today
and current operating mode

MSG #2 Nominal grid voltage configuration and actual line-to-neutral voltage measurements:

Gridtype - 208V
L1 120V L2 120V

Gridtype and phase-to-neutral
voltages

MSG #3 Actual AC power output and DC input:

Pac	4500W
Vpv	380V

AC power
and DC voltage

MSG #4 Accumulated yield of the device since installation and the total operating hours:

E-total	724.4kWh
h-total	512h

Total energy yield
and total operating hours

Fault Messages

In case of a fault condition the LCD switches to “Fault” mode and the backlight is activated.

The upper display line indicates one of the three following failure types:

- **Disturbance**

For example, this Disturbance message would be displayed if the SB6000U detected a problem with the frequency of the utility grid. The message would clear automatically once the condition was corrected. Disturbances are typically caused by a measured value exceeding a predetermined limit, the frequency of the AC grid for example. The display will show the value of the error (at:) as well as the present value for the particular parameter (present:).

**Disturbance
Fac-Bfr**

Disturbance Message

**at: 59.31Hz
present: 59.30Hz**

Disturbance Details

- **Warning**

For example, this Warning message would be displayed if the inverter detected a problem with the fans. Typically, Warning messages indicate a system condition that should be investigated. Warning conditions will not preclude inverter operation.

**WARNING
Fan Block?**

Warning Message

- **Error**

For example, this Error message would be displayed if the inverter detected a problem with the internal ROM. An Error condition will preclude the inverter from restarting until the condition is cleared.

**Error
ROM**

Error Message



Note: Each fault message is displayed for 5 seconds. After 5 seconds, the LCD will once again scroll through its normal operating screens. The fault condition will be included in the series of screens until the condition is cleared.

Communication Options

Sunny Boy inverters are available with different communication options depending upon your needs. The Sunny Boy 6000U series allows for both internal and external metering options to be used simultaneously. These options may also be installed in the field by qualified personnel.

PC Applications and Monitoring

Sunny Boy operating data may be transmitted to, and stored in, a remote system or PC by one of the following methods:

- **Powerline:** Data is sent using the electrical wiring in the building as transmission lines. Powerline communication is only supported by one of the Sunny Boy Control devices.
- **RS-232:** Data from one inverter is sent via an RS-232 cable to a remote control unit or PC. Maximum length of cable is 50' (15 m).
- **RS-485:** Data from up to 50 inverters is sent via RS-485 cable to a remote control unit or to a PC. Maximum length of cable is 4000' (1200 m). An RS-485/232 converter may be necessary for communication with a PC.

Sunny Data

This Windows based application has a user friendly graphical interface that allows you to continuously acquire and evaluate the performance data from your PV system. Each Sunny Boy inverter and the PV strings connected to them can be viewed independently for optimal performance evaluation.

Sunny Data Control

This PC application is used to communicate with the Sunny Boy Control products. It can be used to monitor multiple inverters, download historical system data and adjust system parameters. It can also send system data to the Sunny Server portal via analog modem or ethernet.

Sunny Boy Control Family

The Sunny Boy Control products provide continuous monitoring and data acquisition of your PV system. In addition to the original Sunny Boy Control, you can now choose between the economical Sunny Boy Control Light or the full featured Sunny Boy Control Plus.

For more information and assistance in choosing the right data option for your system, please visit the SMA America web site.

Sunny Beam

The Sunny Beam is a wireless desktop system monitor. It works together with the Sunny Beam Piggy-Back option and provides wireless communication with up to four Sunny Boys in the PV plant. Its graphic display shows a bar chart of actual efficiency as well as daily and total-energy-yields in a single window.

LCD Display Language Selection

The LCD Display has the ability to display information in one of four different languages. Setting the language is performed by using a pair of slide switches located along the bottom edge of the display PC board. The language choices are: Spanish, English, French and German. Use the diagram and chart below for setting the display.

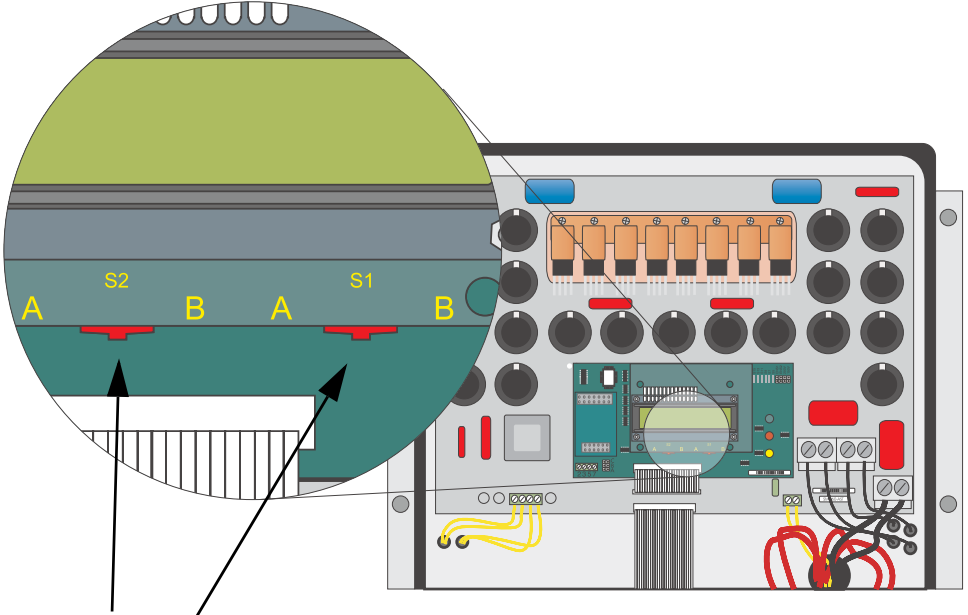

Position of the switches for configuration of the LCD Display language

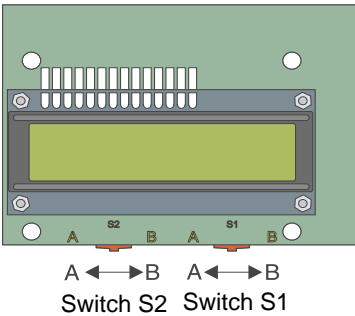

Language	Switch S2	Switch S1
German	B	B
English	B	A
French	A	B
Spanish	A	A

Figure 7-3 Language Selection Switches for the LCD Display

Measuring Channels

The communication options support a number of measuring channels and messages from the Sunny Boy inverters.

The following abbreviations are used:

BFR Betriebsführungsrechner (Sequential Control System)

SRR Stromregelungsrechner (Current Control System)

Measuring Channels

V_{pv}: PV input voltage

V_{pv} Setpoint: MPPT DC voltage target

I_{ac}: Grid current

V_{ac}: Grid voltage

F_{ac}: Grid frequency

P_{ac}: Power fed to grid

V_{pv}-PE: PV-voltage to earth (For troubleshooting PV ground faults)

I_{pv}: PV current

E-Total: Total energy yield

h-Total: Total operation hours

h-on: h-on indicates how long sufficient DC voltage has been applied to the Sunny Boy and the Sunny Boy has been active including the time it was not able to feed to the utility with respect to low DC voltage or operation in stop mode.

Power On: Total system start-up counter

Serial Number: Serial number of the Sunny Boy

Mode: Current operating mode

Grid Type: Type of grid the Sunny Boy is connected to

Error: Description of fault

Operating Mode

Stop:	Manual system stop
Offset:	Offset calibration of the electronics (at start-up)
Waiting:	PV voltage is not high enough to start
Grid monitoring:	Synchronizing to grid (at start-up)
MPP-Search:	MPPT range test (at start-up)
MPP:	Sunny Boy is in MPP mode (normal operation)
V-Const:	Sunny Boy is in constant voltage MPP mode
Derating:	Reduction of the grid feeding power due to abnormal heatsink temperatures
Disturbance:	Grid related fault condition, self clearing
Error:	Inverter fault, user interaction required
Warning:	System warning advising further investigation

Sunny Boy 6000U Operating Parameters



CAUTION: The changing of operating parameters should only be performed by qualified personnel. Changes to factory preset parameters may adversely effect inverter operation and performance.

Table 7-1 Operating Parameters of the Sunny Boy 6000U

Name	Unit	Range	Default	Password Level	Description
E_Total	kWh	0 ... 200000	0		Total energy yield (E_Total) and total operating hours (h_Total) of the inverter. Changing the value can be necessary when a Sunny Boy is exchanged and you wish to match the previously acquired data.
h_Total	h	0 ... 200000	0		
Vconst-Setval	V		600		PV Setpoint voltage for constant voltage operation. These parameters only are important in case the parameter "Operating Mode" is set to "V-const".
Vpv-Start	V	150 ... 400	300		Minimum DC voltage for the Sunny Boy to connect to the grid.
T-Start	s	5 ... 1600	10 / 300		The time the inverter waits to connect to the grid after Vpv-Start is exceeded. This value defaults to 5 minutes after a utility fault.
T-Stop	s	1 ... 1800	2		The time that the Sunny Boy waits to disconnect from the grid when Pac falls below 10W.
T-Stop-Fan	°C	0 ... 100	40		Fan turn-off temperature
T-Start-Fan	°C	0 ... 100	50		Fan turn-on temperature at minimum rotating speed.
T-Max-Fan	°C	0 ... 100	75		Temperature for maximum fan rotation speed.
Fan-Test		1 / 0	0		By setting this parameter to "1" you can check the function of the fans. This test turns the fans at maximum speed.

Name	Unit	Range	Default	Password Level	Description
Operating Mode		MPP-Operation Turbine V-const Stop	MPP		Operating Modes of the Sunny Boy: MPP-Operation: Maximum Power Point V-const: Constant Voltage Mode (Setpoint defined in "Vconst-Setval") Turbine: Operating mode for wind power plants Stop: Disconnection from utility, no operation
Memory Function		no function Default param. Reset Op.Data Reset errors	no function		Default param.: Sets all parameters to default. Reset Op.Data: Sets all parameters that are visible in user level to default values. Reset errors: Resets all permanent device disable errors.

The following parameters appear in parameter list but cannot be modified:

Table 7-2 Operating Parameters of the Sunny Boy 6000U (Fixed)

Name	Unit	Range	Default	Description
Plimit	W	6000		Upper limit of AC output power
SMA-SN				Serial Number of the Sunny Boy
Software-BFR				Firmware version of the operation control unit (BFR)
Software-SRR				Firmware version of the current control unit (SRR)
Hardware-BFS				Hardware version of the DC converter control unit (DC-BFR)
Vac-Min	%	Fixed	12	Lower and upper limits of allowable AC voltage
Vac-Max	%	Fixed	10	
Fac-delta-	Hz	Fixed	0.69	Maximum allowable operating frequency above and below 60 Hz
Fac-delta+	Hz	Fixed	0.49	
dFac-MAX	Hz/s	Fixed	0.5	Maximum "rate of frequency change" before anti-islanding protection engages
Default		Fixed	USA/ UL1741	Used for adjusting the parameters country specific settings.
Storage		Fixed	permanent	permanent: changed parameters are stored in EEPROM and are still available after restarting the Sunny Boys volatile: prevents storing the parameters in EEPROM, (i.e. parameters are only saved until next startup.)

Section 8:

Troubleshooting

General

Our quality control program assures that each inverter is manufactured to exact specifications and is thoroughly tested before leaving the factory. If you encounter difficulty with the operation of your inverter, please follow the steps below in an effort to correct the problem.

- Check the blinking code on the lid of the SB6000U and compare the code with the blinking codes in Chapter 6.
- Check and record the exact "Mode" and/or "Error" messages on the LCD display or other communication system available. Take appropriate action to correct the issue.
- If necessary, check the DC and AC voltages at terminals inside the inverter. Be sure to observe all of the safety precautions listed throughout this manual when doing so, or hire a qualified professional.
- If the system problem persists, contact technical support at: 530.273.4895

In order to better assist you when contacting SMA America, please provide the following information. **This information is required for service assistance.**

Information Regarding the SB6000U:

- Serial number
- Model Number
- Short description of the problem
- Blinking Code (Chapter 6) or display message
- What error code is indicated? (Provided a communication option is installed)
- AC line voltage
- DC line voltage
- Check GFDI Fuse
- Can you reproduce the failure? If yes, how?
- Has this problem occurred in the past?
- What were the ambient conditions when the problem occurred?

Information Regarding the PV modules:

- Manufacturer name and model number of the PV module
- Output power of the module
- Open circuit voltage (Voc) of the module
- Number of modules in each string

If it becomes necessary to send the Sunny Boy back to the manufacturer for service, please ship it in the original box to avoid damage during shipping.

Error Messages

In case of an fault, the SB6000U generates an error code according to the operating mode and the detected fault.

Error Type	Error Code	Description
Disturbance	Vac-Bfr Vac-Srr	<p>The AC grid voltage is exceeding the available range. ("Bfr" or "Srr" is an internal message and is not important for the user.) Vac can also result from a disconnected grid or a disconnected AC cable. The Sunny Boy assumes that the public grid is down and disconnects from the grid in order to avoid islanding.</p> <p>Check the grid voltage and the grid cable connection in the Sunny Boy enclosure. If the grid voltage is out of range due to your local grid conditions contact the utility company and ask, if it is possible to modify the utility conditions. If the grid voltage is within the tolerable range and you still observe the failure message "Vac-Bfr" or "Vac-Srr" contact SMA.</p>
Disturbance	Fac-Bfr Fac-Srr	<p>The AC grid frequency is exceeding the permissible range. ("Bfr" or "Srr" is an internal message and is not important to the user.) The Sunny Boy assumes that the public grid is down and disconnects from the grid in order to avoid islanding.</p> <p>Check the grid frequency and the grid cable connection in the Sunny Boy enclosure. If the grid frequency is out of range due to your local grid conditions contact the utility company and ask, if it is permissible to change the grid monitoring parameters of the inverter. Contact SMA about how to change the grid monitoring parameters of your Sunny Boy. If the grid frequency is within the tolerable range and you still observe the failure message "Fac-Bfr" or "Fac-Srr" contact SMA.</p>
Disturbance	Imax	<p>Overcurrent on the AC side. This failure code is indicated in case the current to the AC grid exceeds the specification. This may happen in case of harmful interference on the grid. If you observe "Imax" often, check your grid. For assistance contact SMA.</p>
Warning	VpvMax	DC input voltage above the tolerable maximum value
Error	MSD-UAC MSD-VAC MSD-FAC MSD-Idif	Internal measurement comparison error: The Sunny Boy measured values of BFR and SRR are too different from each other.

Error Type	Error Code	Description
Error	K1-Close K1-Open K2-Open	Relay test failed
Error	EEPROM	Transition failure during reading or writing of data EEPROM, the data is not essential for safe operation - this failure does not effect performance.
Error	EEPROM p	Data EEPROM defective, device is set to permanent disable due to the fact that the data loss affects important functions of the inverter. Contact SMA.
Error	OFFSET	Grid monitoring self-test failed.
Error	ROM	The internal test of the Sunny Boy control system firmware failed. Contact SMA in case you observe this failure often.
Error	Watchdog	Watchdog for operation control triggered
Error	Bfr-Srr	Communication between micro-controllers is failing
Error	Shut-Down	Internal over current continuous
Error	EarthCur- Max-S	SRR-earth current between PV+ and GND is out of tolerable range
Error	EarthCur- Max-B	BFR-earth current between PV+ and GND is out of tolerable range
Error	GFDI Fuse Ope	The GFDI-Fuse is defective
Error	Derating	The inverter derates his power because of high temperature
Error	XFMR_TEMP _F	High transformer temperature, the Sunny Boy 6000U stops working and the fans work with maximum speed.
Error	XFMR_TEMP _W	High transformer temperature is gone. The Sunny Boy 6000U starts working and shows the failure "XFMR_TEMP_W". Check the function of the fans.
Error	EeRestore	Internal failure
Error	Grid-Time- out Grid-Fault-S	The type of grid could not be detected (208/240/277 V). In case you are connecting to the 277 V grid, check up if the cables for L1 and N are mixed up.

Error Type	Error Code	Description
Error	VacL1-Bfr VacL2-Bfr VacL1-Srr VacL2-Srr	Voltage is too high or too low
Disturbance	XFMR	Transformer is connected to the wrong grid. Check the connection of the transformer.

Section 9:

Maintenance

The SB6000U is designed to provide many years of trouble-free service. Performing regular maintenance will help ensure the long life and high efficiency of your system.

Cleaning the Fans

The fan intakes and exhaust fins should be cleaned periodically with a vacuum cleaner. (Do not blow air into the fan areas) For deeper cleanings, the fans can be removed completely.

The fans are mounted on a plate on the bottom side of the Sunny Boy 6000U. To clean or replace the fans please follow the steps below:

- Turn OFF the DC disconnect and the AC disconnect.
- Remove the six screws on the bottom side of the Sunny Boy 6000U.

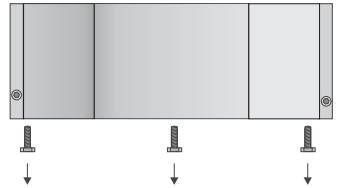

- Carefully remove the plate with the fans and disconnect the power cables leading to the inside of the inverter.

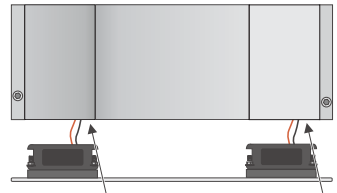

- The fans are mounted to the plate with four nuts each. Unscrew the four nuts and remove the fans, the spacers and filters located behind each fan.

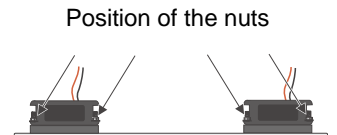

- To clean the fans, spacers and filters use a soft brush or cloth. Do not use air pressure for cleaning the fans. This will damage the fans.
- When the fans are clean, reinstall them using the above steps in reverse order.
- **Do not** blow air through the fans or the fan screens while the fan plate is assembled on the SB6000U.

Testing the Fans

You can verify the operation of the fans in two ways:

- Set the parameter "Fan Test" to "1" (with Sunny Data, Sunny Data Control or with the data logger Sunny Boy Control).

or

- Use the jumpers on the control board of the Sunny Boy 6000U (see Figure 9-1).

After setting the jumper, turn off the inverter and wait until the LED's go out. Once the LED's are out, switch on the inverter. (The Sunny Boy 6000U will not detect the jumper until you cycle power to the inverter.)

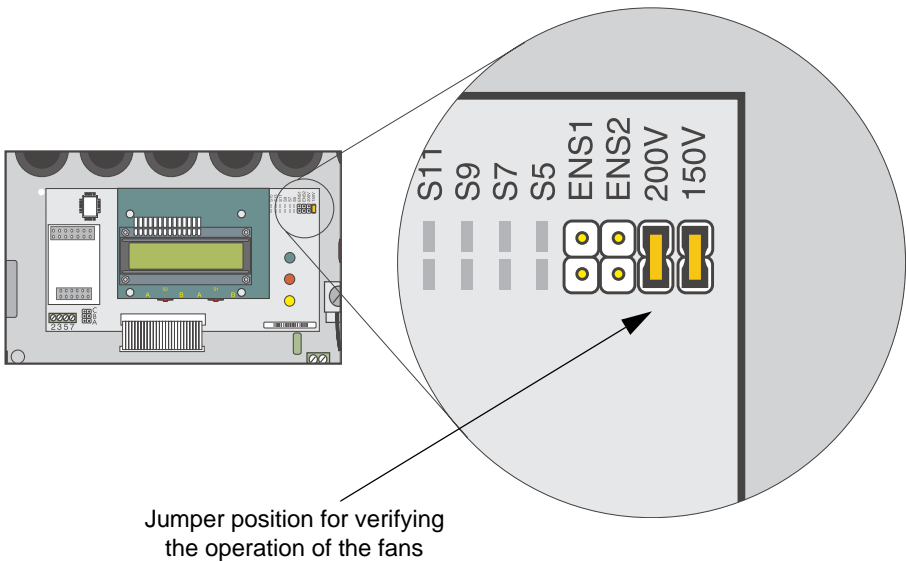
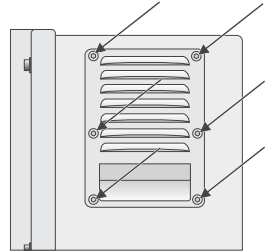

Figure 9-1 Jumper Position

Cleaning the Exhaust Fins

The fins mounted on both sides of the Sunny Boy 6000U are the fan cooling air exhaust ports. To clean the fins, follow the steps below.

- Turn OFF the DC disconnect and the AC disconnect.
- Remove the six mounting screws on either side of the Sunny Boy 6000U and remove the fin plate.



- The filters are mounted behind the fins. Before cleaning the filters, remove them from the fin plates.
- Clean the filters and fin plates with a soft brush or cloth. Use mild soap and water if necessary.
- When the fins and filters are clean, reinstall them using the above steps in reverse order.

Position of the filter

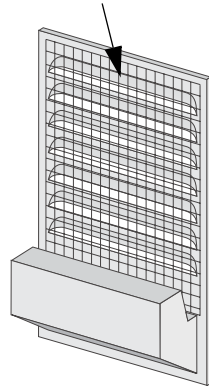

Section 10: Technical Specifications

FCC Compliance Information

Sunny Boy Utility Interactive Inverter, Model SB6000U

This device complies with Part 15 of the FCC Rules. Operation is subject to the following conditions:

- (1) This device may not cause harmful interference, and
- (2) this device must accept any interference received, including interference that may cause undesired operation.

NOTE: This equipment has been tested and found to comply with the limits for a Class B digital device, pursuant to Part 15 of the FCC Rules. These limits are designed to provide reasonable protection against harmful interference in a residential installation. This equipment generates, uses, and can radiate radio frequency energy and if not installed and used in accordance with the instructions, may cause harmful interference to radio communications. However, there is no guarantee that interference will not occur in a particular installation. If this equipment does cause harmful interference to radio or television reception, which can be determined by turning the equipment off and on, the user is encouraged to try to correct the interference by one or more of the following measures:

- Reorient or relocate the receiving antenna.
- Increase the separation between the equipment and the receiver.
- Connect the equipment into an outlet on a circuit different from that to which the receiver is connected.
- Consult the dealer or an experienced radio/TV technician for help.
- **The user is cautioned that changes or modifications not expressly approved by SMA America, Inc. could void the user's authority to operate this equipment.**

Contact SMA America for more information.

12438 Loma Rica Drive

Grass Valley, CA 95945, USA

530.273.4895

www.sma-america.com

Sunny Boy SB6000U Wiring Diagrams

Sunny Boy Connections for 208 and 240 V AC grids

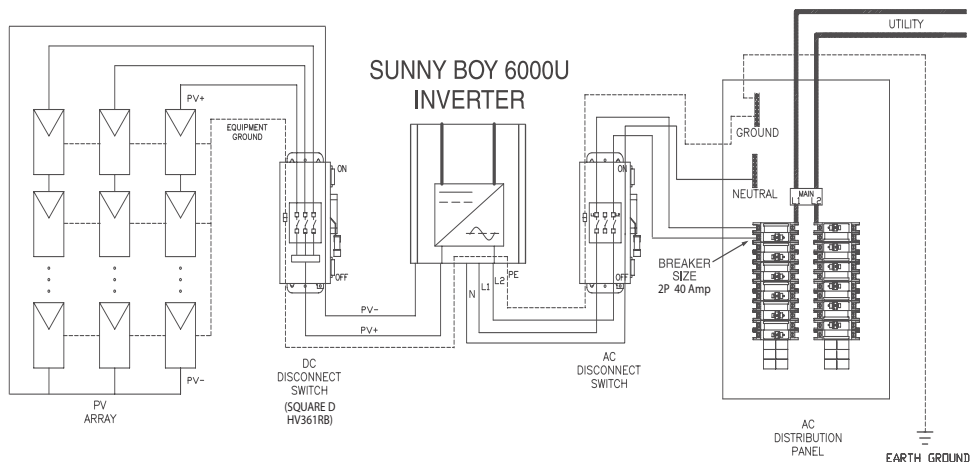

Sunny Boy Connections for 277 V AC grids

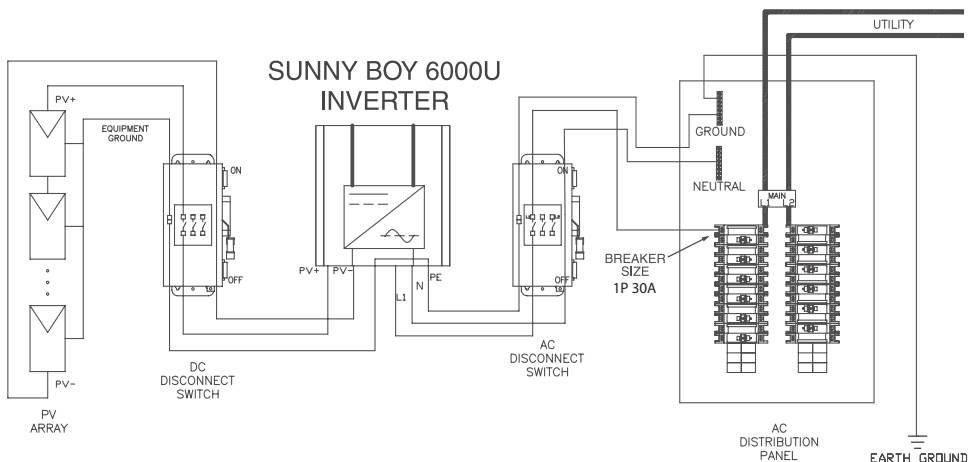

Specifications

Inverter Technology	Sine-wave, current source, high frequency PVM
AC Interface Voltage	183 - 229 (208 V) 213 - 262 (240 V) 244 - 305 (277 V)
AC Interface Frequency	59.3 - 60.5 (60 Hz)
Peak Power Tracking Voltage	600 V DC
Minimum DC Input Voltage	250 V DC
Maximum DC Input Voltage	600 V DC
Maximum Array Input Power (DC@STC)	7200 Wp
Maximum AC Power Output	6000 W
Current THD	Less than 3 %
Power Factor	0.99 @ nominal power
Peak Inverter Efficiency	96 %
Cooling	fan, speed controlled
PV Start Voltage	300 V DC
Maximum AC Output Current	25 A @ 208, 240 VAC 21.7 @ 277 VAC
Maximum DC Input Current	25 A
DC Voltage Ripple	Less than 10 %
Power Consumption	0.1 W nighttime, < 7 W in operation
Ambient Temperature Rating	45°C
Enclosure	NEMA 3R. (IP54) stainless steel

Dimensions	16.94 W x 23.64 H x 9.84 D inches (430 W x 600 H x 250 D mm)
Weight	141 lbs. (63 kg)
Compliance	UL1741, E210376, UL 1998, IEEE 519, IEEE 929, ANSI C62.41 D1 & C3, FCC Part 15 A & B

Specifications subject to change without notice.

SMA America. Inc.

www.sma-america.com

12438-C Loma Rica Drive
Grass Valley, CA 95945
USA
Phone +1 530 273 4895
Fax +1 530 274 7271
www.sma-america.com



Headquarters:
Hannoversche Str. 1-5
34266 Niestetal
Deutschland
Phone +49 561 9522 0
Fax +49 561 9522 100
www.SMA.de

